

A collection of various FORCE brand tools including sockets, wrenches, pliers, and power tools. The tools are arranged on a white background, with some in their original packaging. The FORCE logo is visible on several tools.

FORCE®

FORCE OnDemand II

What is **FORCE OnDemand**?

FORCE OnDemand is You make your own selection and deployment of tools and we realize it for you. This is 100% customization.

Every mechanic and technician has different job focus. And every one has different habit of using tools. Let the tool sets adapted to you instead of you being adapted.

Version IV

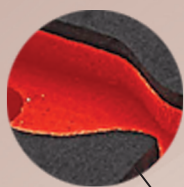

1. For each tool, an exact cut is produced with computer technology which grants easy and quick deployment.

3. The EVA foam is chemical-based and extremely flexible.



2. The exact cuts let recognize immediately where each tool is seated. That saves time and money.

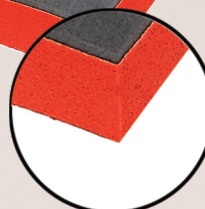

4. Dual color: the upper layer is dark gray, the lower is red.





Power you on!!



Practical series

Packaged Accessories



- Dual-material handle



- 102103P
Strong plastic top tray



- 102170LK
• Foldable key to prevent from breaking due to casual bumping



- Full screw track allows height adjustable



- 102106 / ■ 102106R
■ 102106B / ■ 102106A
Can holder



- Strong caster with brake
- Plastic corner for protection



- Plastic-under provides coldness isolation for hand



Optional Accessories



■ 102104 / ■ 102104R ■ 102104B
Side table



■ 102105 / ■ 102105R
■ 102105B
Paper holder



■ 102102 / ■ 102102R
■ 102102B
Side shelf



■ 102170BBS
• Ball bearing slides
• Only one drawer openable at a time



■ 102101 / ■ 102101R
■ 102101B
Side lock cabinet
With 2 pcs of 82022DW 2" double hooks



No.2208 (detail ref. to P.14)

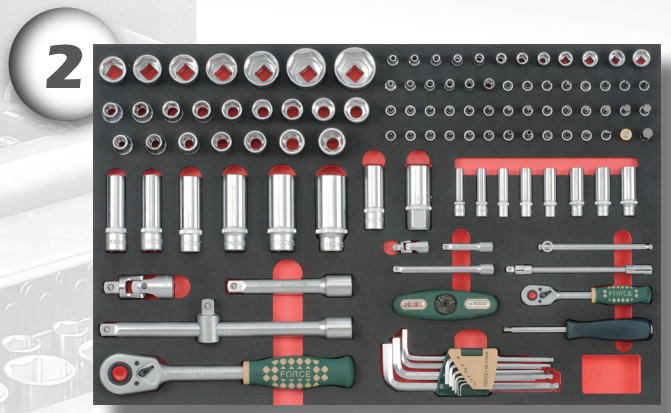

No.41161 (detail ref. to P.24)

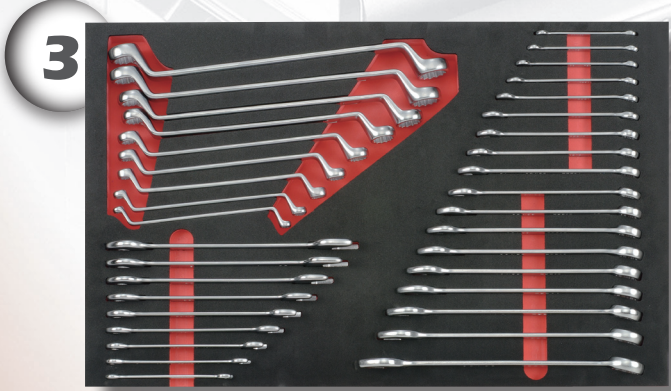

No.5363 (detail ref. to P.34)



No.5212 (detail ref. to P.40)

- 10217-193
- 10218-193
- 10217B-193
- 10218B-193
- 10217R-193
- 10218R-193
- 10217A-193
- 10218A-193



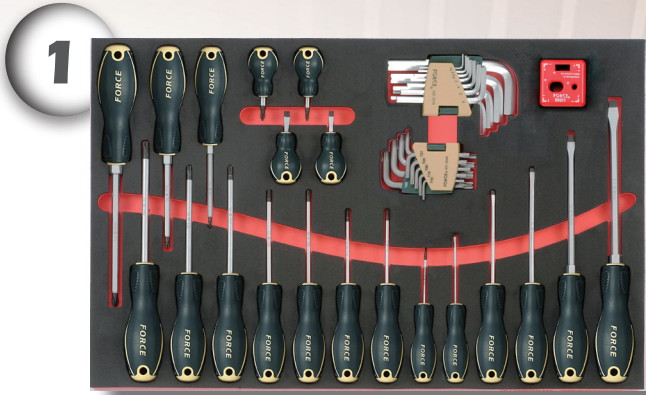

No.2412 (detail ref. to P.15)

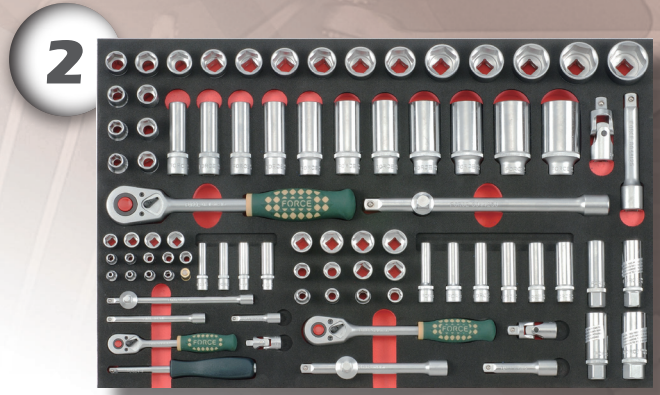

No.4882 (detail ref. to P.22)

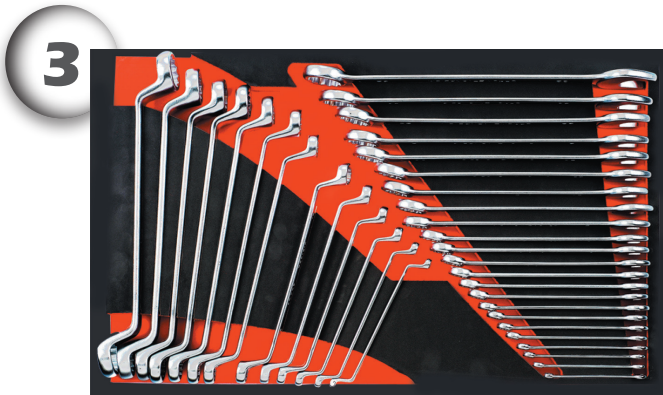

No.5361 (detail ref. to P.33)



No.5155 (detail ref. to P.37)



No.5186 (detail ref. to P.38)

- 10217-198
- 10218-198
- 10217B-198
- 10218B-198
- 10217R-198
- 10218R-198
- 10217A-198
- 10218A-198



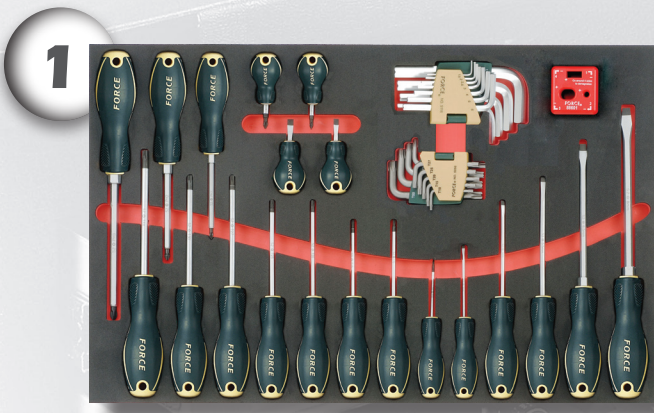

No.2412 (detail ref. to P.15)

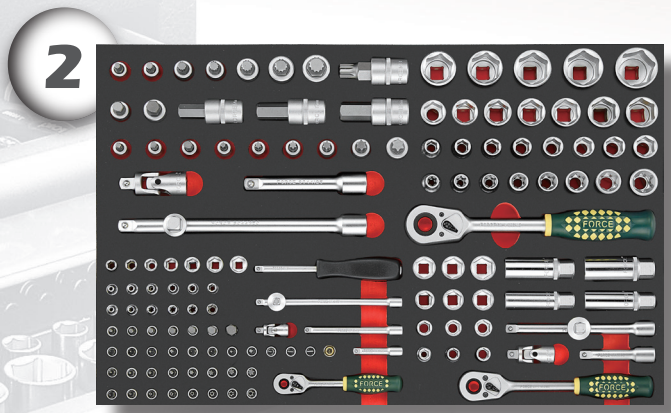

No.41371 (detail ref. to P.25)

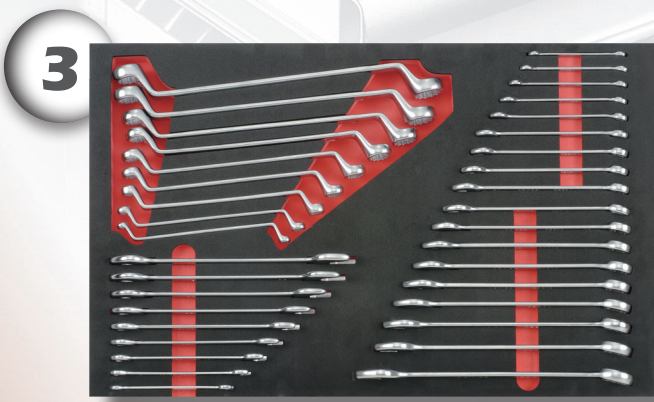

No.5363 (detail ref. to P.34)



No.5179 (detail ref. to P.38)



No.5207A (detail ref. to P.39)

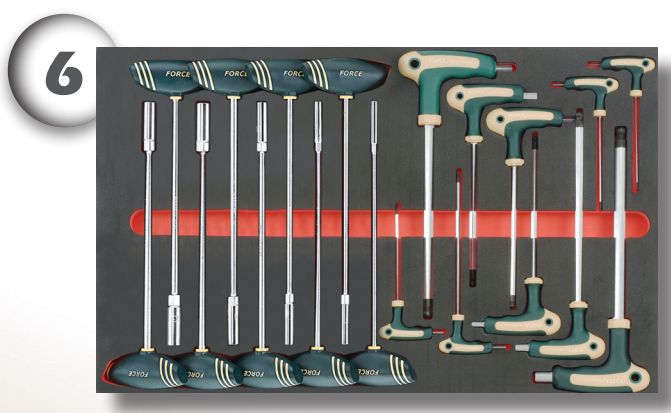

No.2195 (detail ref. to P.28)



- 10217-270
- 10218-270
- 10217B-270
- 10218B-270
- 10217R-270
- 10218R-270
- 10217A-270
- 10218A-270



No.2182 (detail ref. to P.43)



No.3262 (detail ref. to P.43)

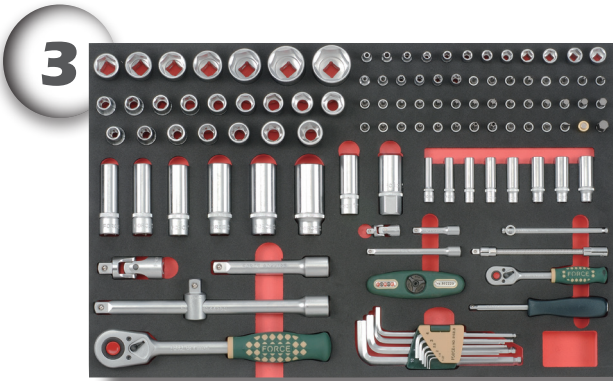

No.41161 (detail ref. to P.24)

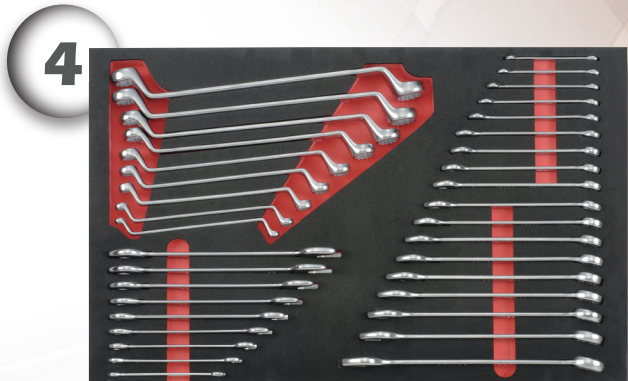

No.5363 (detail ref. to P.34)

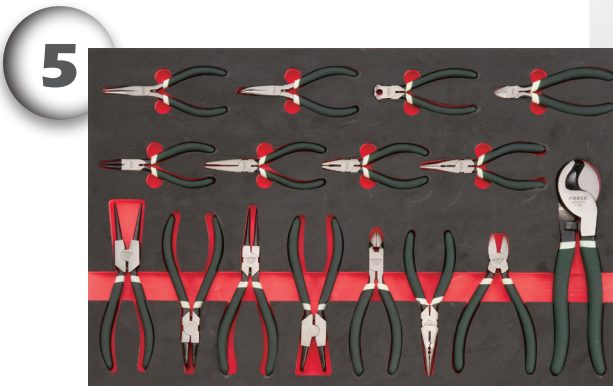

No.51610 (detail ref. to P.37)



No.5212 (detail ref. to P.40)

■ 10217-233

■ 10217B-233

■ 10217R-233

■ 10217A-233

■ 10218-233

■ 10218B-233

■ 10218R-233

■ 10218A-233



1

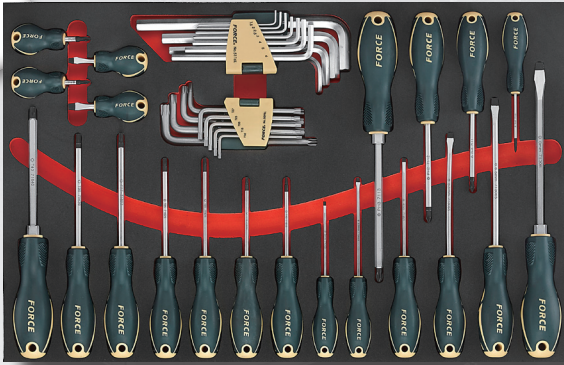

No.2415 (detail ref. to P.15)

2

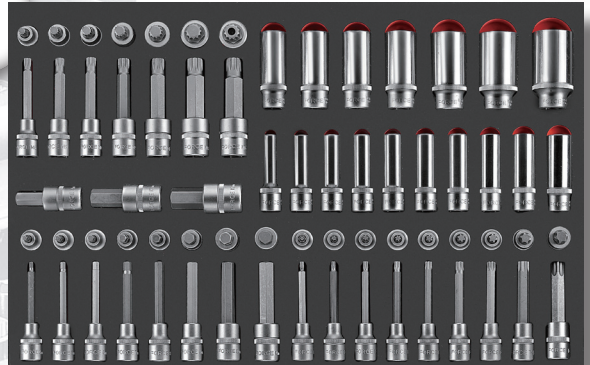

No.4685(detail ref. to P.20)

3

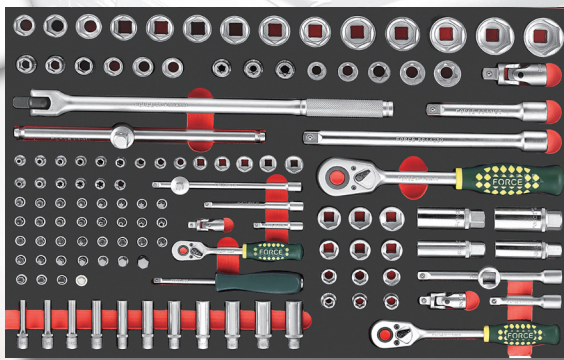

No.41281 (detail ref. to P.24)

4

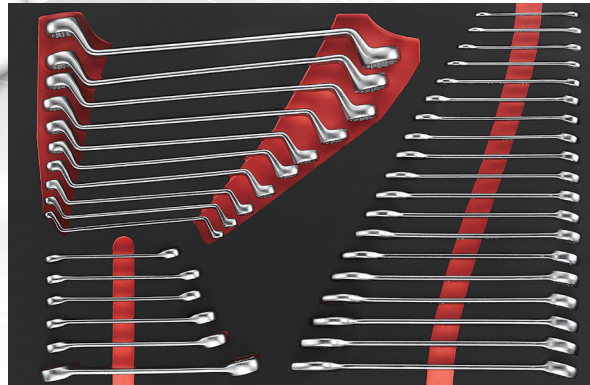

No.5353 (detail ref. to P.33)

5



No.5207 (detail ref. to P.39)

6

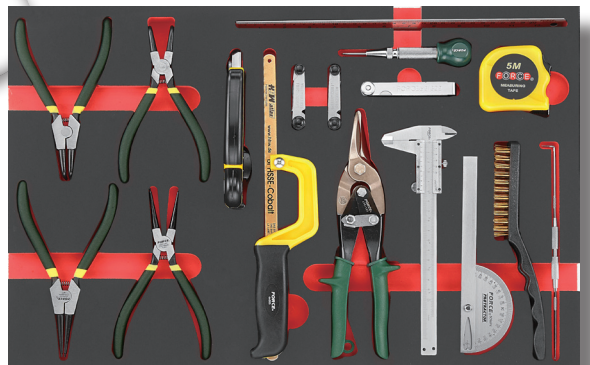

No.5179 (detail ref. to P.38)

7



No.4615 (detail ref. to P.42)

- 10218-370
- 10218B-370
- 10218R-370
- 10218A-370

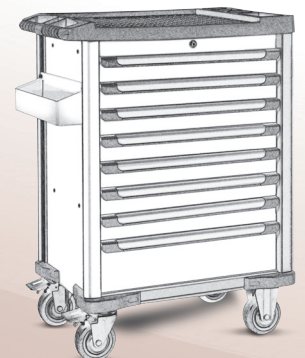

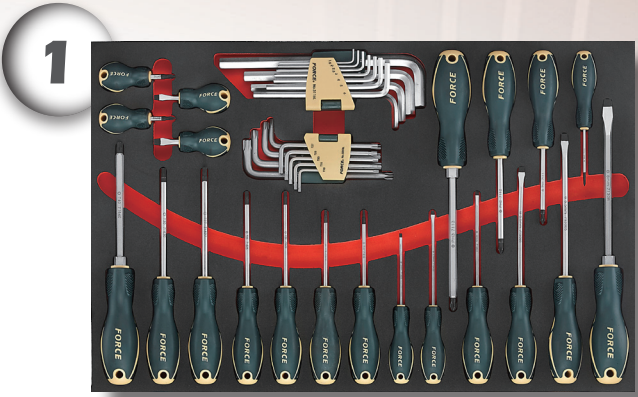

No.2415 (detail ref. to P.15)

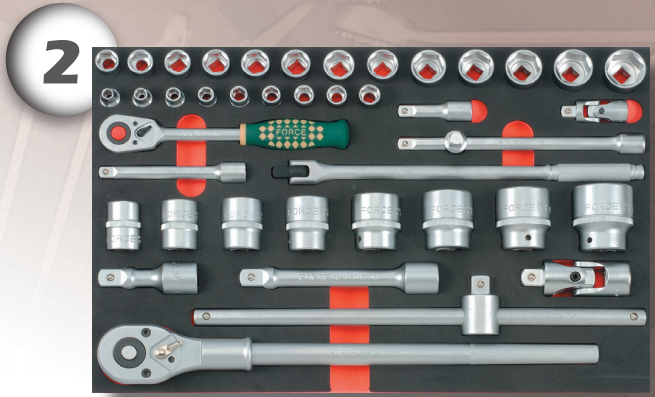

No.6421 (detail ref. to P.26)

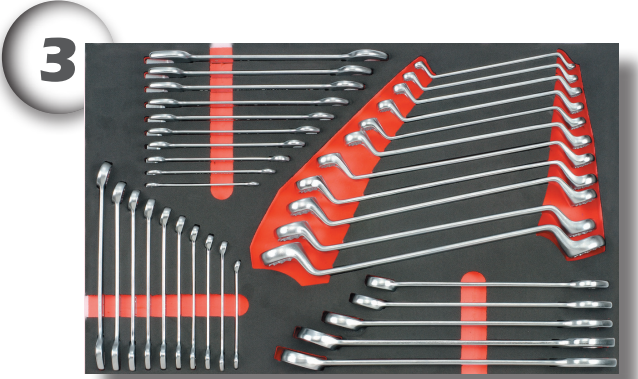

No.5362 (detail ref. to P.34)



No.5155 (detail ref. to P.37)



No.5186 (detail ref. to P.38)



No.4615 (detail ref. to P.42)



No.6321 (detail ref. to P.42)

- 10218-246
- 10218B-246
- 10218R-246
- 10218A-246



1

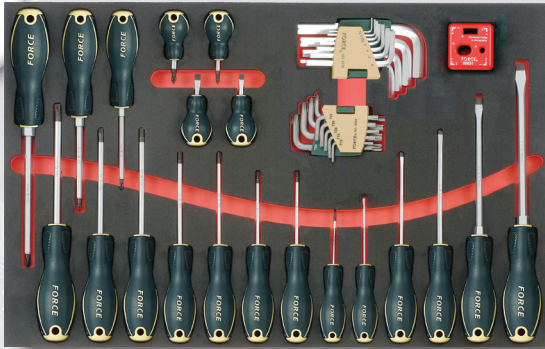

No.2412 (detail ref. to P.15)

2

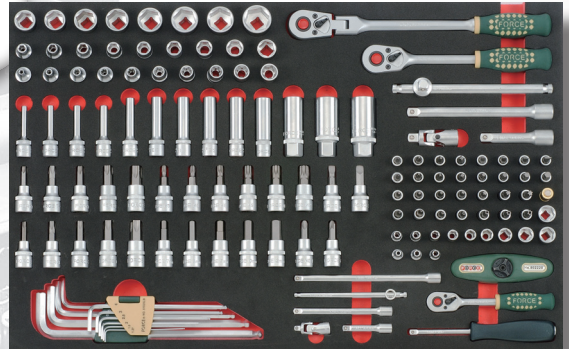

No.31331 (detail ref. to P.17)

3

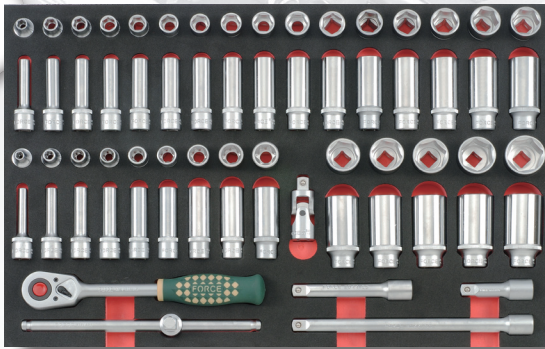

No.4661 (detail ref. to P.19)

4

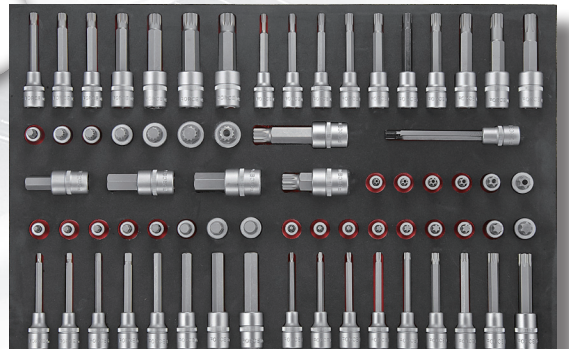

No.4701 (detail ref. to P.20)

5

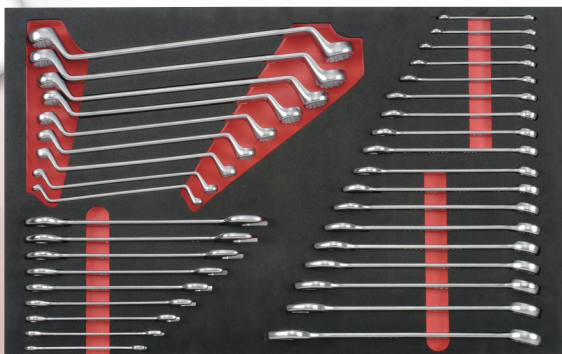

No.5363 (detail ref. to P.34)

6

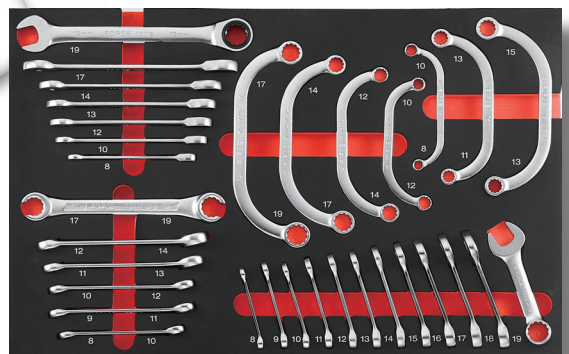

No.5322 (detail ref. to P.32)

7



No.5207A (detail ref. to P.39)

8

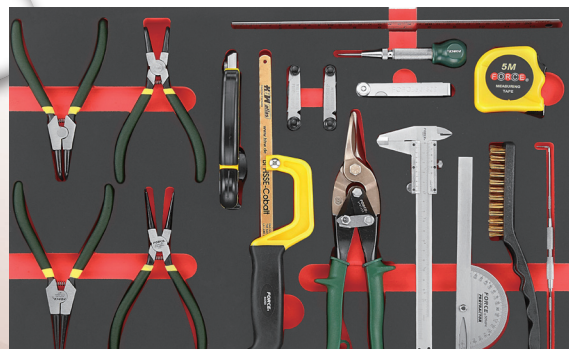

No.5179 (detail ref. to P.38)

■ 10218-415

■ 10218R-415

■ 10218B-415

■ 10218A-415

1

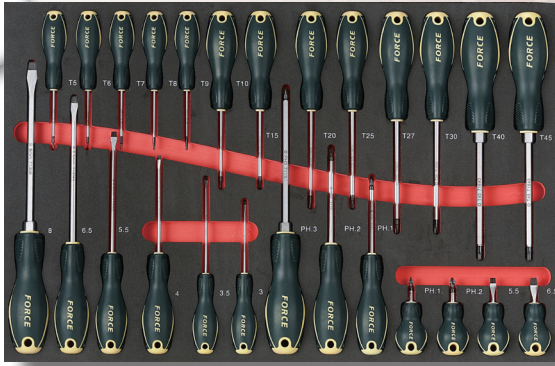

No.2262 (detail ref. to P.14)

2

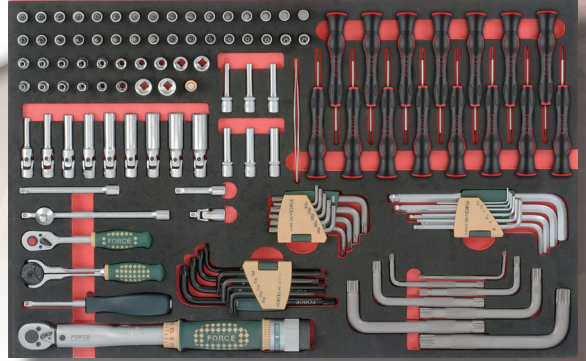

No.21261 (detail ref. to P.16)

3

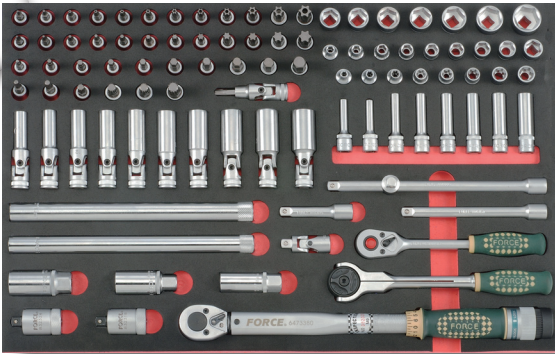

No.3981 (detail ref. to P.16)

4

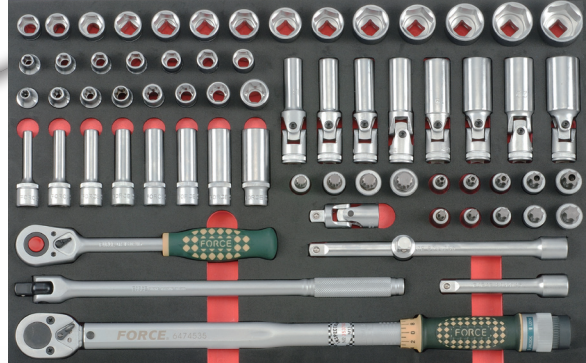

No.4662 (detail ref. to P.20)

5

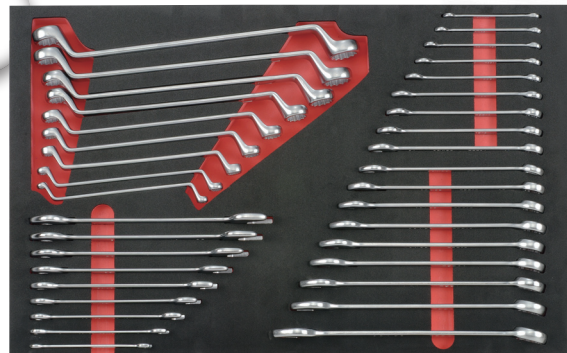

No.5363 (detail ref. to P.34)

6

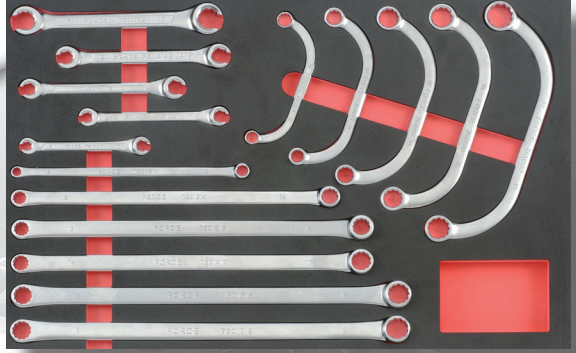

No.5168 (detail ref. to P.29)

7



No.5207 (detail ref. to P.39)

8

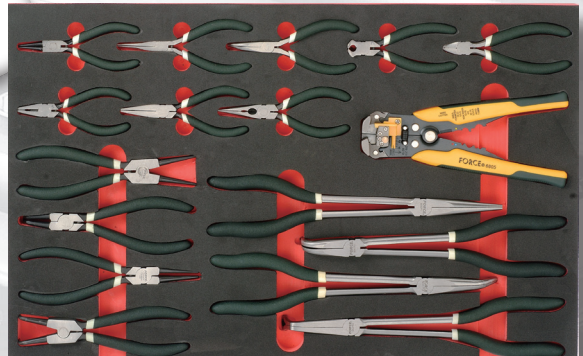

No.5178 (detail ref. to P.37)

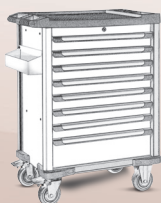

■ 10218-405

■ 10218R-405

■ 10218B-405

■ 10218A-405

1



No.56261 (detail ref. to P.40)

2

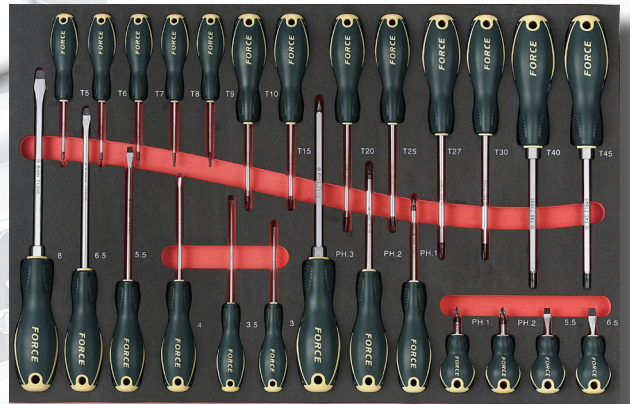

No.2262 (detail ref. to P.14)

3

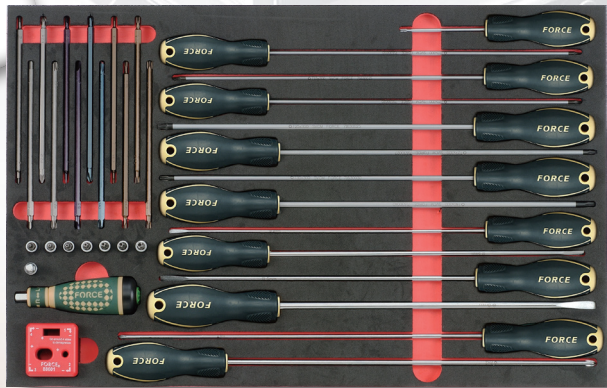

No.2363 (detail ref. to P.14)

4

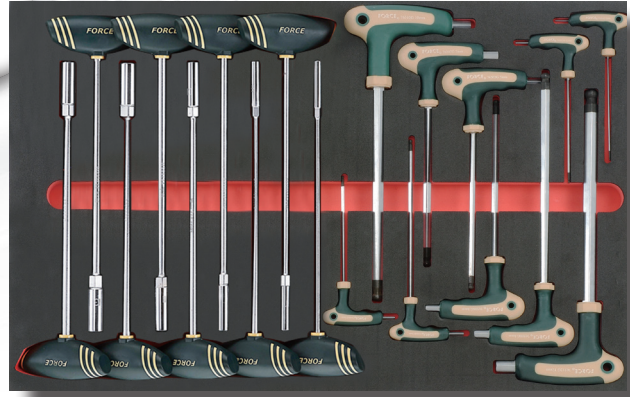

No.2195 (detail ref. to P.28)



5



No.5232(detail ref. to P.40)

- 1013-550
- 1013B-550
- 1013R-550
- 1013A-550

6

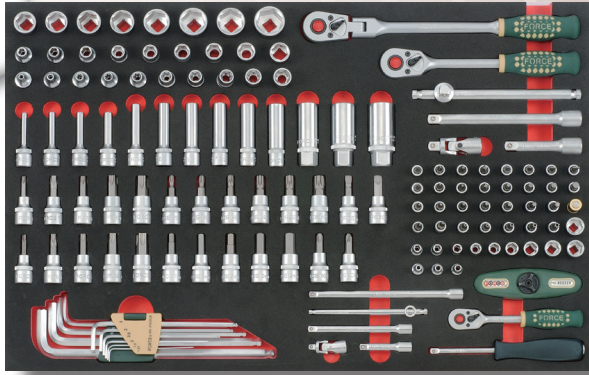

No.31331 (detail ref. to P.17)

7

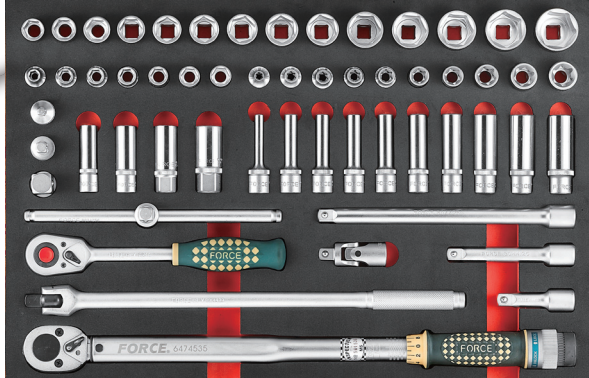

No.4562 (detail ref. to P.18)

8

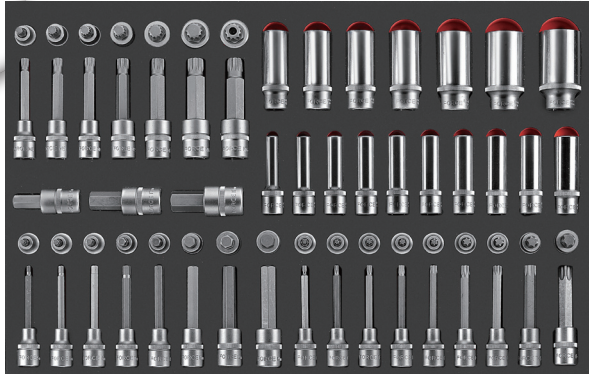

No.4685 (detail ref. to P.20)

9



No.5361 (detail ref. to P.33)

10

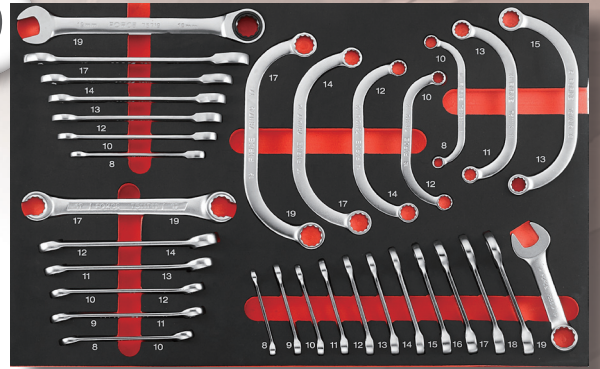

No.5322 (detail ref. to P.32)

11



No.4615 (detail ref. to P.42)

12



No.51311 (detail ref. to P.36)

Screwdriver



NO.2208

20pc Screwdriver & pliers set

- Long Nose pliers 8"
- Combination pliers 7"
- Diagonal pliers 7"
- Waterpump pliers 10"
- Locking pliers 10"
- Adjustable gauged wrench (250mml)
- ⊕ Phillips screwdriver
PH.1x80mml; PH.2x100mml; PH.3x150mml
- ⊕ Stubby Phillips screwdriver (25mml) PH.1; PH.2
- Slotted screwdriver
3mmx75mml; 3.5mmx100mml; 4mmx100mml;
5.5mmx125mml; 6.5mmx150mml; 8mmx175mml
- Stubby slotted screwdriver (25mml) 5.5mm; 6.5mm
- Demagnetizer/Magnetizer

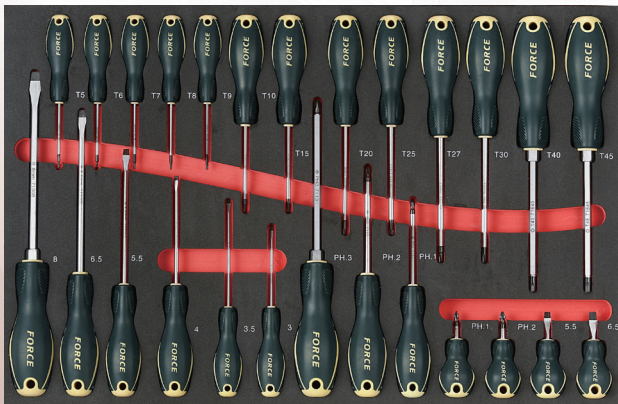

NO.2262

26pc Screwdriver set

- ⊕ Phillips screwdriver
PH.1x80mml; PH.2x100mml; PH.3x150mml
- ⊕ Stubby Phillips screwdriver
PH.1x25mml; PH.2x25mml
- Slotted screwdriver
3mmx75mml; 3.5mmx100mml; 4mmx100mml;
5.5mmx125mml; 6.5mmx150mml; 8mmx175mml
- Stubby slotted screwdriver
5.5mmx25mml; 6.5mmx25mml
- ⊕ Star screwdriver
T5; T6; T7; T8; T9; T10; T15; T20; T25; T27; T30; T40; T45

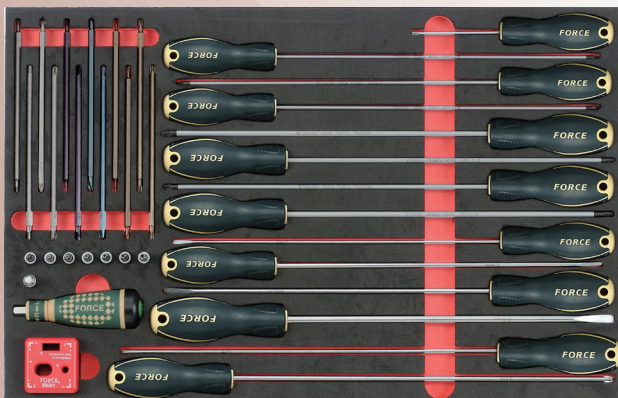

NO.2363

36pc Automotive screwdriver set

- 1/4" Double-sized bit (165mml)
- ⊕ Phillips PH.1xPH.2; PH.3xPH.4
- ⊕ Pozidriv PZ.1xPZ.2; PZ.3xPZ.4
- Slotted 3x4mm; 5.5x7mm
- Hex 3x4mm; 5x6mm
- ⊕ Star T8xT10; T15xT20; T25xT27; T30xT40
- ⊕ 1/4"DR. Five-sided star tamper socket bit
TS10; TS15; TS20; TS25; TS27; TS30; TS40
- Adjustment screwdriver
- ⊕ Phillips 350mml PH.1; PH.2
- Slotted 300mml 4x0.6; 5x0.7; 6x0.9; 8x1.2
- ⊕ Star screwdriver for hard-to-reach fastener
T10; T15; T20; T25; T27; T30; T40 (300mml)
- Spline screwdriver 80mml M4
- Adapter 1/4"hex*1/4"(M)
- Ratchet bit driver handle
- Demagnetizer/Magnetizer

Screwdriver

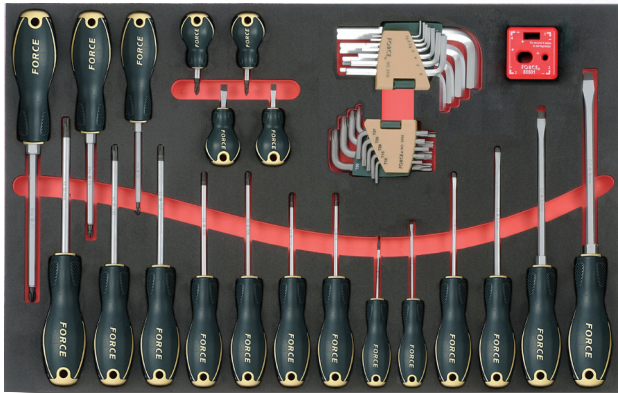

NO.2412

41pc Screwdriver & L key set

- ⊕ Phillips screwdriver PH.0; PH.1; PH.2; PH.3
- ⊕ Stubby Phillips screwdriver PH.1; PH.2
- Slotted screwdriver
3; 4; 5.5; 6.5; 8 mm
- Stubby slotted screwdriver 5.5; 6.5mm
- ⊕ Star screwdriver
T10; T15; T20; T25; T27; T30; T40
- ⊕ Star key
T10; T15; T20; T25; T27; T30; T40; T45; T50
- Hex key
1.5; 2; 2.5; 3; 4; 5; 6; 7; 8; 10; 12 mm
- Demagnetizer/Magnetizer

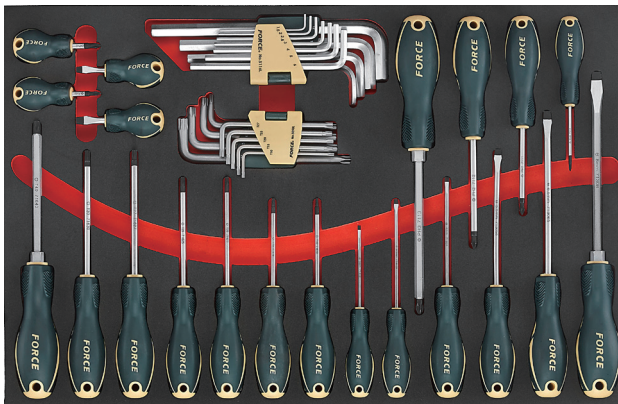

NO.2415

41pc Screwdriver & L key set

- ⊕ Phillips screwdriver PH.0; PH.1; PH.2; PH.3
- ⊕ Stubby Phillips screwdriver PH.1; PH.2
- Slotted screwdriver
3; 3.5; 4; 5.5; 6.5; 8 mm
- Stubby slotted screwdriver 5.5; 6.5mm
- ⊕ Star screwdriver
T10; T15; T20; T25; T27; T30; T40
- ⊕ 9pc Star long key
T10; T15; T20; T25; T27; T30; T40; T45; T50
- 11pc Hex long key
1.5; 2; 2.5; 3; 4; 5; 6; 7; 8; 10; 12 mm

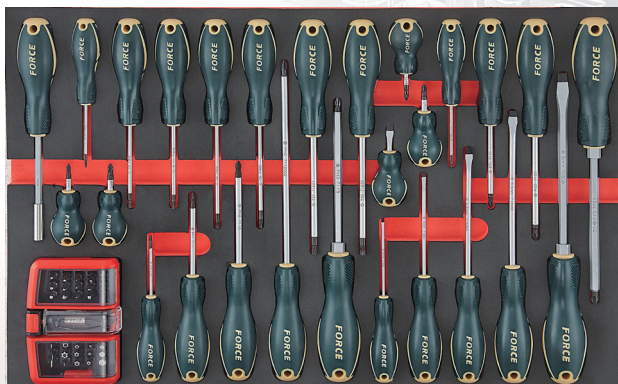

NO.2581

58pc screwdriver set

- Slotted screwdriver 3; 4; 5.5; 6.5; 8 mm
- Slotted stubby screwdriver 5.5 mm
- ⊕ Phillips screwdriver PH.0; PH.1; PH.2; PH.3
- ⊕ Phillips stubby screwdriver PH.1; PH.2
- ⊕ Phillips screwdriver (200mmL) PH.2
- ⊕ Pozidriv stubby screwdriver PZ.1; PZ.2
- ⊕ Pozidriv screwdriver PZ.0; PZ.1; PZ.2; PZ.3
- ⊕ Star screwdriver T8; T10; T15; T20; T25; T27; T30
- 1/4" Mag. bit holder spinner
- 31pc Bit set
Magnetic bit holder 60mmL (81260Q)
- ⊕ 1/4" Phillips bit PH.0, PH.1x2, PH.2x2, PH.3
- ⊕ 1/4" Pozidriv bit PZ.0, PZ.1x2, PZ.2x2, PZ.3
- 1/4" Slotted bit 3, 4, 5, 6.5
- 1/4" Hex bit 2, 2.5, 3, 4, 5, 6 mm
- ⊕ 1/4" Star tamperproof bit T-10H, T-15H, T-20H, T-25H, T-27H, T-30H, T-35H, T-40H

Socket Combination

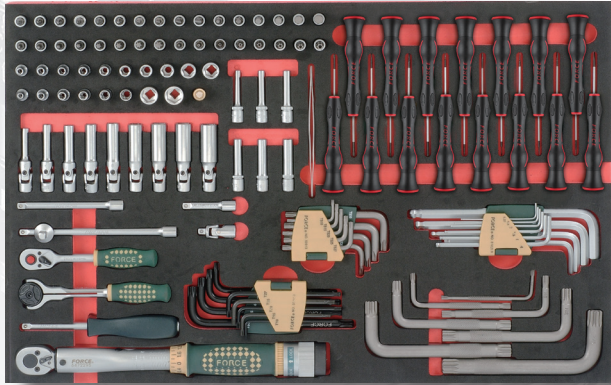

NO.21261

126pc 1/4" DR. Socket combination & L key set

- 6pt. Flank socket 4; 4.5; 5; 5.5; 6; 7; 8; 9; 10; 11; 12; 13 mm
- Universal deep socket 5; 6; 7; 8; 9; 10; 11; 12; 13 mm
- Star socket E4; E5; E6; E7; E8; E10
- Star deep socket (50mml) E4; E5; E6; E7; E8; E10
- Socket bit (32mml)
 - Star T8; T10; T15; T20; T25; T27; T30; T40
 - Star tamper T-8H; T-10H; T-15H; T-20H; T-25H; T-27H; T-30H; T-40H
 - Phillips PH.0; PH.1; PH.2
 - Pozidriv PH.0; PZ.1; PZ.2
 - Lock torques wrench 6-30 Nm
 - Adaptor for extension 3/8"(F)x1/4"(M)
 - 72 teeth flexible round ratchet
 - Magnetic socket pick-up
 - Slotted 3; 4; 5.5; 6.5
 - Hex 3; 4; 5; 6; 7; 8 mm
 - 20 teeth ratchet handle
 - Extension 2"; 4"; 6"
 - Universal joint
 - Spinner
- Others:
 - Hex ball point long key 1.27; 1.5; 2; 2.5; 3; 4; 5; 6; 8; 10 mm
 - Star & star ball point long key T10; T15; T20; T25; T27; T30; T40; T45; T50
 - Five-sided star tamper L key TS10; TS15; TS20; TS25; TS27; TS30; TS40; TS45; TS50
 - Spline key M5; M6; M8; M10; M12; M14; M16
 - Phillips jeweler screwdriver PH.000; PH.00 (40mml)
 - Slotted jeweler screwdriver 1.0; 1.2; 1.5; 1.8; 2.0; 2.4 mm(40mml)
 - Star jeweler screwdriver T5; T6; T7; T8 (40mml)
 - Star tamperproof jeweler screwdriver T5; T6; T7 (40mml)
 - Tweezer

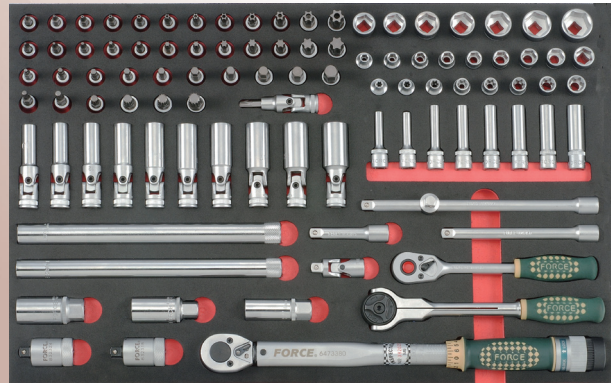

NO.3981

98pc 3/8" DR. Socket combination set

- 6pt. Flank socket (MM) 6; 7; 8; 9; 10; 11; 12; 13; 14; 15; 16; 17; 18; 19; 21; 22 mm
- 6pt. Flank Universal socket 10; 11; 12; 13; 14; 15; 16; 17; 18; 19mm
- Star socket E6; E7; E8; E10; E11; E12; E14; E16
- Star deep socket E6; E7 (55mml); E8; E10; E11; E12; E14; E16 (63mml)
- Hex socket bit 3; 4; 5; 5.5; 6; 7; 8; 9; 10; 12 mm
- Star socket bit T8; T10; T15; T20; T25; T27; T30; T40; T45; T50; T55; T60
- Star tamperproof socket bit T-8H; T-10H; T-15H; T-20H; T-25H; T-27H; T-30H; T-40H; T-45H; T-50H; T-55H; T-60H
- Spline socket bit M5; M6; M8; M9; M10; M12
- Universal star socket bit T45
- Torque wrench
- 72 teeth Ratchet handle
- Flexible ratchet handle
- Extension 75; 150; 225 mm
- Universal joint
- Adaptor for extension 3/8"(F)x3/8"(M)
- Spark plug socket 16; 18; 20.6 mm
- Magnetic long spark plug socket 14; 16 mm
- Torque adapter 18Nm; 24Nm

Socket Combination

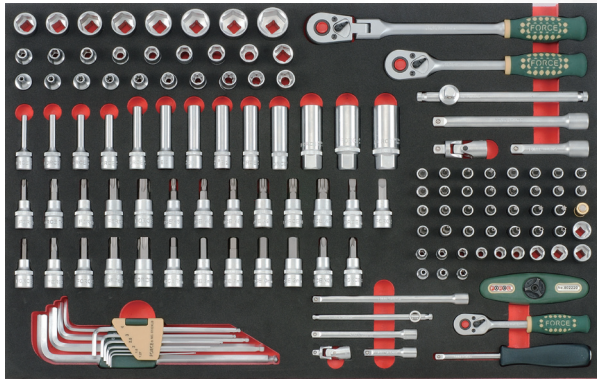

NO.31331

133pc 1/4" & 3/8" DR. Socket combination set

Content: 1/4" & 3/8" DR.

1/4" DR. Part

- 6pt. Flank socket
3.2; 4; 4.5; 5; 5.5; 6; 7; 8; 9; 10; 11; 12; 13 mm

Socket bit (32mmL)

- ⊕ Phillips PH.0; PH.1; PH.2; PH.3
- ⊕ Pozidriv PZ.0; PZ.1; PZ.2; PZ.3
- Slotted 3; 4; 5.5; 6.5 mm
- Hex 3; 4; 5; 6 mm
- ⊕ Star T8; T10; T15; T20; T25; T27; T30
- ⊕ Star tamperproof T-8H; T-10H; T-15H; T-20H; T-25H; T-27H; T-30H

Ratchet handle (20 teeth)

T mini ratchet
Extension 2" & 4" & 6"

Sliding T handle

Universal joint
Magnetic socket pick-up

Spinner

3/8" DR. Part

- 6pt. Flank socket (MM)
6; 7; 8; 9; 10; 11; 12; 13; 14; 15; 16; 17; 18; 19; 20; 21; 22 mm

- Star socket
E4; E5; E6; E7; E8; E10; E11; E12; E14; E16

- Star deep socket
E4; E5; E6; E7 (55mmL)
E8; E10; E11; E12; E14; E16 (63mmL)

Socket bit 3/8" (50 mml)

- ⊕ Phillips PH.4
- ⊕ Pozidriv PZ.4
- Slotted 7; 8 mm
- Hex 7; 8; 9; 10; 12 mm
- ⊕ Star T40; T45; T50; T55; T60
- ⊕ Star tamperproof T-40H; T-45H; T-50H; T-55H; T-60H

- Spline M5; M6; M8; M9; M10; M12

Ratchet handle
Flexible ratchet handle
Extension 3" & 6"
Universal joint
Sliding T bar

- Spark plug socket 16 ; 18; 20.6 mm

Others:

- ⊕ Hex ball point extra long key
1.27; 1.5; 2; 2.5; 3; 4; 5; 6; 8; 10 mm

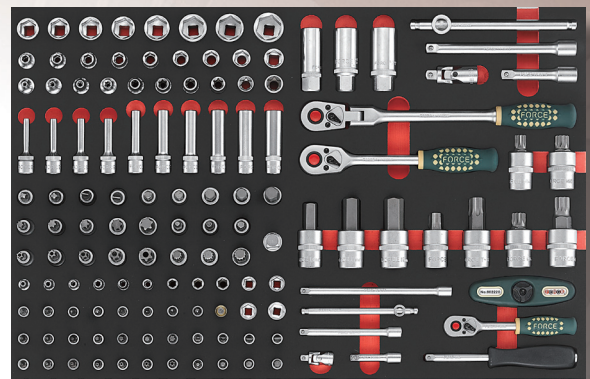

NO.31332

133pc 1/4" & 3/8" & 1/2" DR. Socket combination set

Contents: 1/4 & 3/8 & 1/2" DR.

1/4" DR. Part

- 6pt. Flank socket
3.2; 4; 4.5; 5; 5.5; 6; 7; 8; 9; 10; 11; 12; 13 mm

Socket bit (32mmL)

- ⊕ Phillips PH.0; PH.1; PH.2; PH.3
- ⊕ Pozidriv PZ.0; PZ.1; PZ.2; PZ.3
- Slotted 3; 4; 5.5; 6.5 mm
- Hex 3; 4; 5; 6 mm
- ⊕ Star T8; T10; T15; T20; T25; T27; T30
- ⊕ Star tamperproof T-8H; T-10H; T-15H; T-20H; 25H; T-27H; T-30H

Ratchet handle (20 teeth)

T mini ratchet
Extension 2" & 4" & 6"

Sliding T handle

Universal joint
Magnetic socket pick-up

Spinner

3/8" DR. Part

- 6pt. Flank socket (MM)
6; 7; 8; 9; 10; 11; 12; 13; 14; 15; 16; 17; 18; 19; 20; 21; 22 mm

- Star socket
E4; E5; E6; E7; E8; E10; E11; E12; E14; E16

- Star deep socket
E4; E5; E6; E7 (55mmL)
E8; E10; E11; E12; E14; E16 (63mmL)

Socket bit 3/8" (50 mml)

- ⊕ Phillips PH.4
- ⊕ Pozidriv PZ.4
- Slotted 7; 8 mm
- Hex 7; 8; 9; 10; 12 mm
- ⊕ Star T40; T45; T50; T55; T60
- ⊕ Star tamperproof T-40H; T-45H; T-50H; T-55H; T-60H
- Spline M5; M6; M8; M9; M10; M12

Ratchet handle (30 teeth)

Flexible ratchet handle
Extension 3" & 6"

Universal joint

Sliding T bar

- Spark plug socket 16 ; 18; 20.6 mm
Adaptor 3/8"(F)x1/2"(M)

1/2" DR. Part

- 1/2" Hex socket bit (65mmL) 14
- 1/2" Hex socket bit (70mmL) 17; 19
- ⊕ 1/2" Star socket bit (55mmL) T70
- ⊕ 1/2" Star socket bit (70mmL) T80
- 1/2" Spline socket bit (55mmL) M14; M16
- 1/2" Spline T.socket bit (55mmL) M16
- 1/2" Spline socket bit (70mmL) M18

Socket Combination

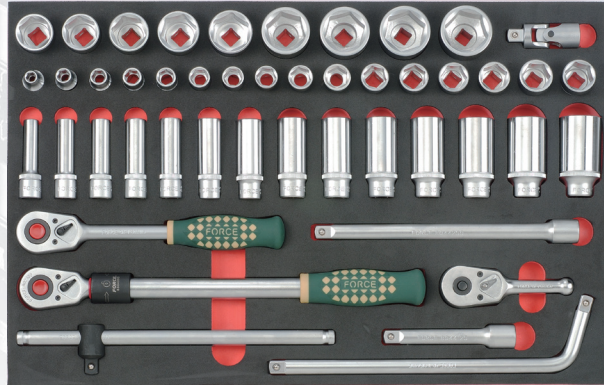

NO.4483

48pc 1/2" DR. Socket combination set

- 6pt. Flank socket
8; 10; 11; 12; 13; 14; 15; 16; 17; 18; 19; 20; 21;
22; 23; 24; 26; 27; 28; 30; 32; 33; 34; 35; 36 mm
- 6pt. Flank deep socket (77mmL)
10; 12; 13; 14; 15; 17; 19; 21; 22; 23; 24; 27; 30; 32 mm
- 36 teeth ratchet handle
- Stubby ratchet handle 45 teeth
- Ratchet handle
- 105°L handle 315mmL
- Adjustable handle (turn-lock design)
- Sliding T bar
- Extension bar 5"; 10"
- Universal joint

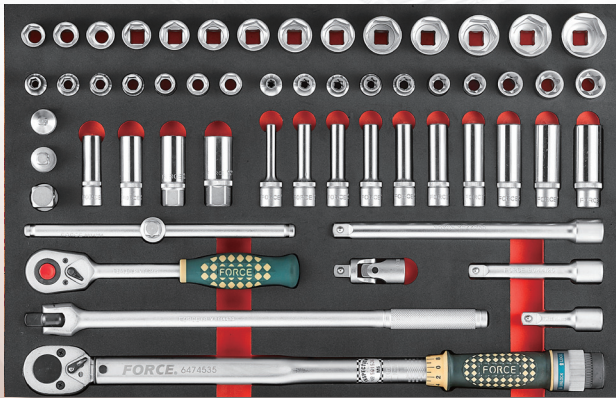

NO.4562

56pc 1/2" DR. Socket combination set

- 6pt. Flank socket
8; 10; 11; 12; 13; 14; 15; 16; 17; 18; 19; 20; 21; 22; 23; 24; 26;
27; 28; 30; 32 mm
- Star socket
E8; E10; E11; E12; E14; E16; E18; E20; E22; E24
- Star deep socket (77mmL)
E8; E10; E11; E12; E14; E16; E18; E20; E22; E24
- Ratchet handle 36 teeth
- Lock torque wrench
- Sliding T handle 10" (250mmL)
- Extension 3"; 5"; 10"
- Universal joint
- Swivel handle 17"
- Spark plug socket 14; 16; 18; 20.6 mm
- Adaptor
1/2"(F)x 1/4"(M); 1/2"(F)x3/8"(M); 1/2"(F)x 3/4"(M)

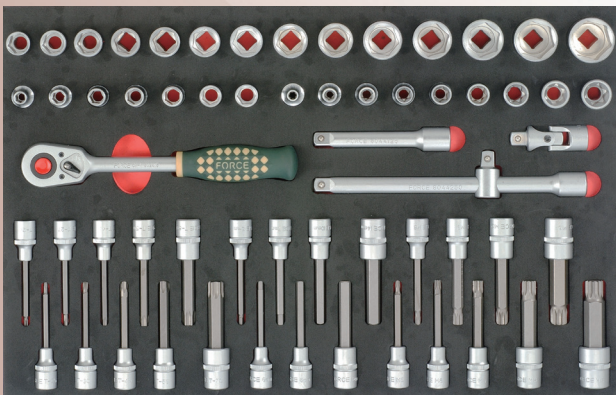

NO.4613

61pc 1/2" DR. Socket combination set

- 6pt. Flank socket
8; 10; 11; 12; 13; 14; 15; 16; 17; 18; 19;
20; 21; 22; 23; 24; 26; 27; 28; 30; 32 mm
- Star socket
E8; E10; E12; E14; E16; E18; E20; E22; E24
- Socket bit (100mmL)
 - Hex 5; 6; 7; 8; 10; 12; 14mm
 - Star T20; T25; T27; T30; T40; T45; T50; T55; T60; T70
 - Spline M5; M6; M8; M9; M10; M12; M14; M16; M18
- Ratchet handle
- Extension 5" & 10"
- Universal joint
- Adaptor for ext. 3/8"(F)x1/2"(M)

Socket Combination

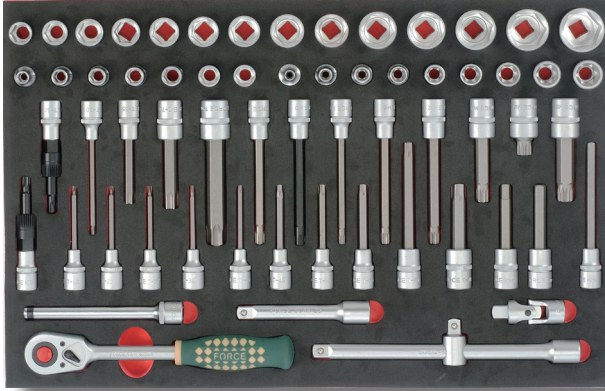

NO.4655

65pc 1/2" DR. Auto socket bit combination set

- 6pt. Flank socket
8; 10; 11; 12; 13; 14; 15; 16; 17; 18; 19;
20; 21; 22; 23; 24; 26; 27; 28; 30; 32 mm
- Star socket
E8; E10; E12; E14; E16; E18; E20; E22; E24
- Star deep socket E12 (150mml)
- Socket bit
 - Hex 11; 13 mm (100mml)
 - Hex 10 mm (140mml)
 - Star T20; T25; T27; T30; T40; T45; T50; T55; T70 (100mml)
 - Star T60 (140mml)
 - Star tamperproof T-55H (100mml)
 - Star tamperproof T-70H (105mml)
 - Star tamperproof T-30H (130mml)
 - Star tamperproof T-80H (140mml)
 - Spline security M16 (55mml)
 - Spline M14 (100mml)
 - Spline security M16 (100mml)
 - Spline M8; M10; M12 (140mml)
 - Ribe M9 (140mml)
 - Ribe M10 (140mml)
- M10 Alternator tools
 - Spline (XZN) socket bit M10x110mml
 - Reaction corkscrew cap 33 teeth-Ø19mm-17mm hex
- T50 Alternator tools
 - Star socket bit T50x110mml
 - Reaction corkscrew cap 33 teeth-Ø19mm-17mm hex
 - Ratchet handle
 - Extension 5" & 10"
 - Universal joint
 - Adaptor for ext. 3/8"(F)x1/2"(M)

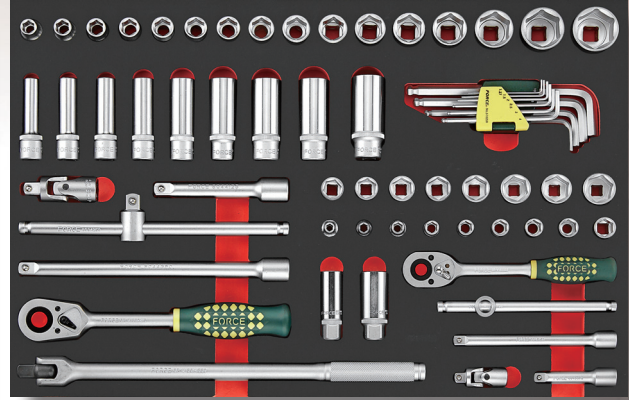

NO.4656

65pc 3/8" & 1/2" DR. Socket combination set

- Contents: 3/8" & 1/2" DR.
- 3/8" part
- 6pt. Flank socket
6; 7; 8; 9; 10; 11; 12; 13; 14; 15; 16; 17; 18; 19; 20; 21; 22 mm
 - Ratchet handle
 - Sliding T handle 165mml
 - Extension 3"; 6"
 - Universal joint
 - Spark plug socket 16; 20.6 mm
- 1/2" DR. Part
- 6pt. Flank socket
10; 11; 12; 13; 14; 15; 16; 17; 18; 19; 21; 22; 24; 27; 30; 32 mm
 - 6pt. Flank socket (77mml)
10; 12; 13; 14; 17; 19; 21; 22; 24 mm
 - Swivel handle 380mml 15"
 - Ratchet handle-36 teeth
 - Sliding T handle 250mml
 - Extension 5" & 10"
 - Universal joint
- Others
- 10pc Hex ball long key
1.27; 1.5; 2; 2.5; 3; 4; 5; 6; 8; 10 mm

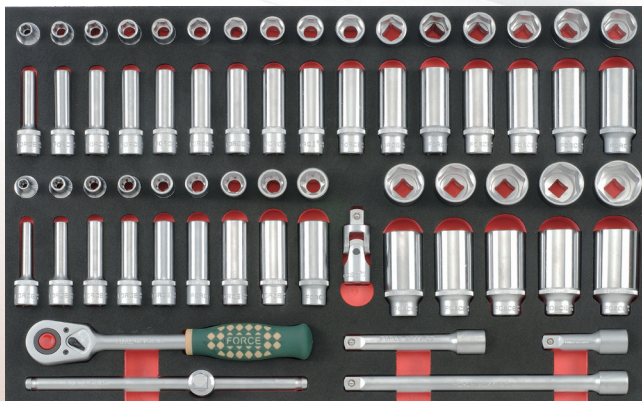

NO.4661

66pc 1/2" DR. Socket combination set

- 6pt. Flank socket
8; 10; 11; 12; 13; 14; 15; 16; 17; 18; 19;
20; 21; 22; 23; 24; 26; 27; 28; 30; 32 mm
- 6pt. Flank deep socket (77mml)
8; 10; 11; 12; 13; 14; 15; 16; 17; 18; 19;
20; 21; 22; 23; 24; 26; 27; 28; 30; 32 mm
- Star socket
E8; E10; E12; E14; E16; E18; E20; E22; E24
- Star deep socket
E8; E10; E12; E14; E16; E18; E20; E22; E24
- Ratchet handle 36 teeth
- Sliding T handle 10"(250mml)
- Extension 3"; 5"; 10"
- Universal joint

Socket Combination

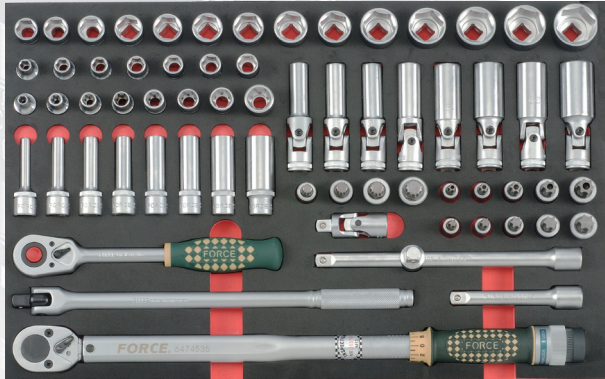

NO.4662

66pc 1/2" DR. Socket combination set

- 6pt. Flank socket
8; 10; 11; 12; 13; 14; 15; 16; 17; 18; 19; 20; 21; 22; 23; 24; 26; 27; 28; 30; 32 mm
- Universal 6pt. Flank socket 13; 14; 15; 17; 19; 21; 22; 24 mm
- Star socket E8; E10; E12; E14; E16; E18; E20; E24
- Star deep socket E8; E10; E12; E14; E16; E18; E20; E24
- Star socket bit (55mmL) T45; T50; T55; T60; T70
- Star tamper socket bit (55mmL) T-45H; T-50H; T-55H; T-60H; T-70H
- Spline socket bit (55mmL) M10; M12; M14; M16
- Lock torque wrench Swivel handle 15"
- 36 teeth ratchet handle Extension 5" & 10"
- Adaptor for ext. 3/8"(F)x1/2"(M) Universal joint

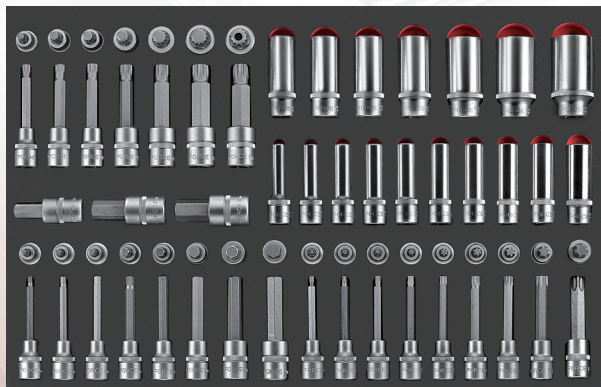

NO.4685

68pc 1/2" DR. Socket & socket bit set

- Hex socket bit (55mmL) 4; 5; 6; 7; 8; 10; 11; 12 mm
- Hex socket bit (65mmL) 14 mm
- Hex socket bit (70mmL) 17; 19 mm
- Hex socket bit (100mmL) 4; 5; 6; 7; 8; 10; 12; 14 mm
- Star socket bit (55mmL)
T20; T25; T27; T30; T40; T45; T50; T55; T60
- Star socket bit (100mmL)
T20; T25; T27; T30; T40; T45; T50; T55; T60
- Spline socket bit (55mmL) M8; M9; M10; M12; M14; M16
- Spline T.socket bit (55mmL) M16
- Spline socket bit (100mmL) M8; M9; M10; M12; M14; M16
- Spline T.socket bit (100mmL) M16
- 6pt. Flank deep socket
8; 10; 11; 12; 13; 14; 15; 16; 17; 18; 19; 21; 22; 24; 27; 30; 32 mm

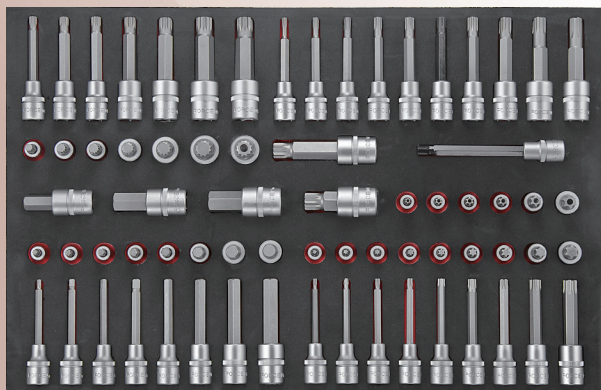

NO.4701

70pc 1/2" DR. Socket bit set

- Hex socket bit (55mmL) 4; 5; 6; 7; 8; 10; 11; 12 mm
- Hex socket bit (65mmL) 14 mm
- Hex socket bit (70mmL) 17; 19 mm
- Hex socket bit (100mmL) 4; 5; 6; 7; 8; 10; 12; 14 mm
- Star socket bit (55mmL)
T20; T25; T27; T30; T40; T45; T50; T55; T60
- Star socket bit (100mmL)
T20; T25; T27; T30; T40; T45; T50; T55; T60
- Star T. socket bit (55mmL)
T30H; T40H; T45H; T50H; T55H; T60H
- Spline socket bit (55mmL) M8; M9; M10; M12; M14; M16
- Spline T.socket bit (55mmL) M16
- Spline socket bit (70mmL) M18
- Spline socket bit (100mmL) M8; M9; M10; M12; M14; M16; M18
- Spline T.socket bit (100mmL) M16
- Ribe socket bit (100mmL)
M5; M6; M7; M8; M9; M9.5; M10; M12; M13; M14
- Ribe socket bit (140mmL) M10 (for Volks Wagon)

Socket Combination

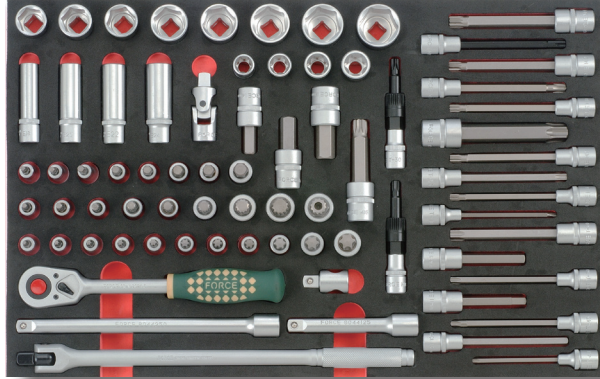

NO. 4751

75pc 1/2" DR. Socket combination set

- 6pt. Flank socket 22; 23; 24; 26; 27; 28; 30; 32 mm
- Star socket E18; E20; E22; E24
- Star deep socket E18; E20; E22; E24
- 1/2" socket bit
 - Hex 4; 5; 6; 7; 8; 9; 10; 12 mm(55mmL)
 - Hex 14 mm(65mmL) ; 17; 19 mm(70mmL)
 - Hex 11; 13 mm(100mmL) ; 10 mm (140mmL)
 - Star T20; T25; T27; T30; T40; T45; T47; T50; T55; T60; T70 (55mmL)
 - Star T40 (120mmL) ; T45; T50; T60 (140mmL)
 - Star tamperproof T-30H (130mmL) ; T-55H; T-80H (140mmL)
 - Spline M5; M6; M8; M9; M10; M12; M14; M16 (55mmL)
 - Spline security M16 (55mmL) ; M16 (100mmL)
 - Spline M8; M9; M10; M12; M14 (140mmL)
 - Ribe M9 ; M10 (140mmL)
- M10 Alternator tools
 - Spline (XZN) socket bit M10x110mmL
 - Reaction corkscrew cap 33 teeth-Ø19mm-17mm hex
- T50 Alternator tools
 - Star socket bit T50x110mmL
 - Reaction corkscrew cap 33 teeth-Ø19mm-17mm hex
 - Swivel handle 15"
 - Ratchet handle Extension 5" & 10"
 - Universal joint adaptor for ext. 3/8"(F)x1/2"(M)

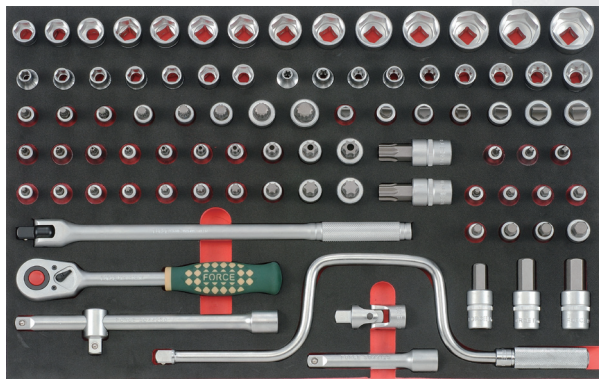

NO. 4881

88pc 1/2" DR. Socket combination set

- 6pt. Flank socket
 - 8; 10; 11; 12; 13; 14; 15; 16; 17; 18; 19;
 - 20; 21; 22; 23; 24; 26; 27; 28; 30; 32 mm
- Star socket
 - E8; E10; E12; E14; E16; E18; E20; E22; E24
- 1/2" socket bit
 - Phillips PH.2; PH.3; PH.4
 - Slotted 8; 9; 10; 11; 12; 14; 16 mm (55mmL)
 - Hex 4; 5; 6; 7; 8; 9; 10; 12 mm (55mmL)
 - Hex 14mm (65mmL)
 - Hex 17; 19 mm (70mmL)
 - Star T20; T25; T27; T30; T40; T45; T50; T55; T60; T70 (55mmL)
 - Star T80 (70mmL)
 - Star tamperproof T-20H; T-25H; T-27H; T-30H; T-40H; T-45H;
 - T-50H; T-55H; T-60H; T-70H (55mmL)
 - Star tamperproof T-80H (70mmL)
 - Spline M5; M6; M8; M9; M10; M12; M14; M16 (55mmL)
- Ratchet handle
 - Extension 5" & 10"
- Swivel handle 15"
 - Adaptor for ext. 3/8"(F)x1/2"(M)
- Universal joint
 - Speed handle

Socket Combination

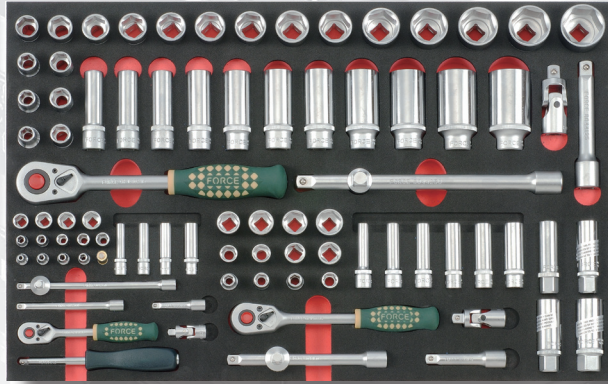

NO.4882

88pc 1/4" & 3/8" & 1/2" DR. Socket combination set

Contents: 1/4" & 3/8" & 1/2"DR.

1/4" part

- 6pt. Flank socket
3.2; 4; 4.5; 5; 5.5; 6; 7; 8; 9; 10; 11; 12; 13 mm
- 6pt. Flank deep socket (50mml) 6; 7; 8; 10 mm
20 teeth ratchet handle
Extension 2" & 4" & 6"
Universal joint
Adaptor for ext. 3/8"(F)x1/4"(M)
Magnetic socket pick-up
Spinner

3/8"DR. Part

- 6pt. Flank socket
8; 9; 10; 11; 12; 13; 14; 15; 16; 17; 18; 19 mm
- 6pt. Flank socket (63mml) 8; 9; 10; 12; 13; 14 mm
30 teeth ratchet handle
Extension 3" & 6"
Universal joint
Adaptor for extension 1/2"(F)x3/8"(M)

- Magnetic spark plug socket 14; 16; 18; 20.6 mm

1/2"DR. Part

- 6pt. Flank socket
10; 11; 12; 13; 14; 15; 16; 17; 18; 19;
20; 21; 22; 23; 24; 26; 27; 28; 30; 32 mm
- 6pt. Flank deep socket (77mml)
13; 14; 15; 17; 19; 21; 22; 24; 27; 30; 32 mm
36 teeth ratchet handle
Extension bar 5"; 10"
Universal joint
Adaptor for ext. 3/8"(F)x1/2"(M)

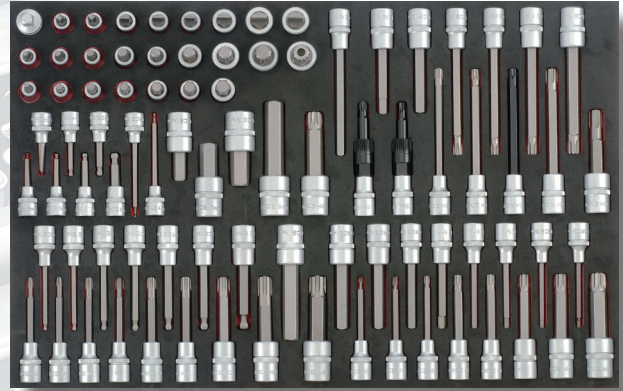

NO.4883

88pc 3/8" & 1/2" DR. Socket bit set

Contents: 3/8" & 1/2"DR.

3/8"DR. Part

- 3/8" Hex ball point socket bit
3; 4; 5; 6; 7; 8; 10 (62mml)
3; 4 (100mml)

1/2"DR. Part
socket bit

- Phillips PH.4
- Pozidriv PZ.4
- Slotted 9; 10; 11; 12; 14; 16 mm
- Hex 5; 6; 7; 8; 9; 10; 12 mm (55mml)
- Hex 14 mm (65mml)
- Hex 17; 19 mm (70mml)
- Hex 5; 6; 7; 8; 9; 10; 11; 12; 13; 14 mm(100mml)
- Hex 17; 19 mm (110mml)
- Hex 10 mm (140mml)
- Hex ball point 5; 6; 7; 8; 9; 10; 12 mm(100mml)
- Spline M5; M6; M8; M9; M10; M12; M14; M16 (55mml)
- Spline security M16 (55mml)
- Spline M5; M6; M8; M9; M10; M12; M14; M16 (100mml)
- Spline security M16 (100mml)
- Spline M9; M10; M12; M14 (140mml)
- Ribe M5; M6; M7; M8; M9; M10; M12; M13; M14; M16(100mml)
- Ribe M8; M9; M12 (140mml)
- Ribe M10 (140mml)

M10 Alternator tools

- Spline (XZN) socket bit M10x110mml
Reaction corkscrew cap 33 teeth-Ø19mm-17mm hex

T50 Alternator tools

- Star socket bit T50x110mml
Reaction corkscrew cap 33 teeth-Ø19mm-17mm hex
Adapter 1/2"(F) - 3/8"(M)

Socket Combination

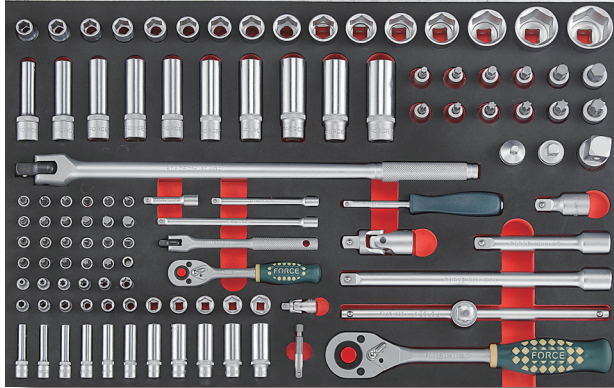

NO.41085

108pc 1/4" & 1/2" DR. combination set

Contents: 1/4" & 1/2" DR.

1/4" part

● 6pt. Flank socket
5; 5.5; 6; 7; 8; 9; 10; 11; 12; 13; 14 mm

● 6pt. Flank deep socket
5; 5.5; 6; 7; 8; 9; 10; 11; 12; 13; 14 mm

● Star socket
E4; E5; E6; E7; E8; E10

socket bit (32mmL)

● Phillips socket bit PH.1; PH.2; PH.3

● Pozidriv socket bit PZ.1; PZ.2; PZ.3

● Slotted socket bit 4; 5.5; 6.5 mm

● Hex socket bit 3; 4; 5; 6; 7; 8 mm

● Star socket bit T8; T10; T15; T20; T25; T27; T30; T40

Extension 50; 100; 150 mmL

Universal joint

Spinner 150mmL

Swivel handle 140 mmL

Ratchet handle

Bit adaptor 1/4"Hex-1/4"Sq.

Magnetic bit holder 1/4"(F)x1/4"(F)

1/2" part

● 6pt. Flank socket
10; 11; 12; 13; 14; 15; 16; 17; 18; 19; 21; 22; 24; 27; 30; 32 mm

● 6pt. Flank deep socket
10; 12; 13; 14; 15; 16; 17; 18; 19; 21 mm

● Hex socket bit (55mmL) 5; 6; 7; 8; 10; 12 mm

● Star socket bit (55mmL) T30; T40; T45; T50; T55; T60

Extension 50; 125; 250 mmL

Universal joint

Swivel handle 430 mmL

Locking Sliding T handle

Ratchet handle

Adaptor 1/2"(F)x1/4"(M); 1/2"(F)x3/8"(M); 1/2"(F)x3/4"(M)

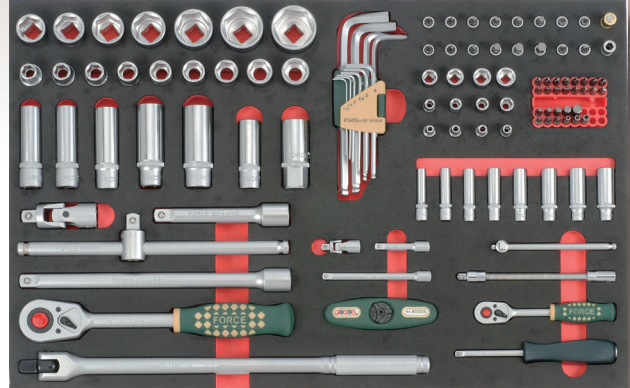

NO.41121

112pc 1/4" & 1/2" DR. Socket combination set

Contents: 1/4" & 1/2" DR.

1/4" part

● 6pt. Flank socket

4; 4.5; 5; 5.5; 6; 7; 8; 9; 10; 11; 12; 13 mm

● 6pt. Flank deep socket (50mmL)
6; 7; 8; 9; 10; 11; 12; 13 mm

Socket bit (32mmL)

● Phillips PH.1; PH.2; PH.3

● Pozidriv PZ.1; PZ.2; PZ.3

● Slotted 3; 4; 5.5; 6.5 mm

● Hex 3; 4; 5; 6; 7; 8 mm

1/4" Security bit (25mmL)

● Torq set 6; 8; 10 mm; 1/4"

● Tri-wing 1; 2; 3; 4

● Spanner 4; 6; 8; 10 mm

● Hex security 2; 2.5; 3; 4; 5; 6 mm

● Square 0; 1; 2; 3

● Spline M4; M5; M6; M8; M10

20 teeth ratchet handle

48 teeth T mini ratchet handle

Sliding T handle 115mmL

Extension 2" & 4"

Universal joint

Bit holder 1/4"(F)x1/4"hex

Flexible extension 145mmL

Magnetic socket pick-up

Spinner

1/2" part

● 6pt. Flank socket

10; 11; 12; 13; 14; 15; 16; 17; 18; 19; 21; 22; 24; 27; 30; 32 mm

● 6pt. Flank deep socket 14; 15; 17; 19; 22 mm
Swivel handle 15"

36 teeth ratchet handle

Sliding T handle 10"

Extension 5" & 10"

Universal joint

● Spark plug socket 16; 20.6mm

Others:

● Hex ball point long key

1.27; 1.5; 2; 2.5; 3; 4; 5; 6; 8; 10mm

Socket Combination

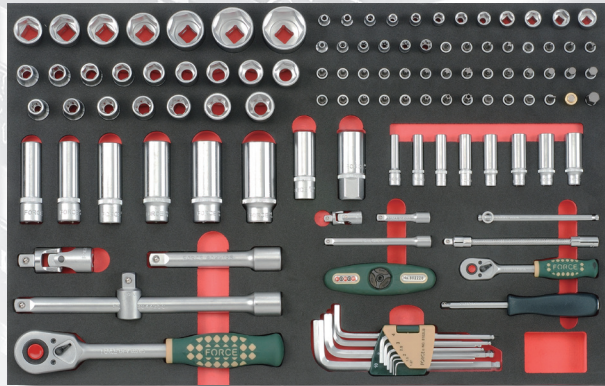

NO.41161

116pc 1/4" & 1/2" DR. Socket set

Contents: 1/4" & 1/2"DR.

1/4" part

- 6pt. Flank socket
4; 4.5; 5; 5.5; 6; 7; 8; 9; 10; 11; 12; 13 mm
- 6pt. Flank deep socket (50mml)
6; 7; 8; 9; 10; 11; 12; 13 mm
- Star socket E4; E5; E6; E7; E8; E10
- Socket bit (32mml)
- Phillips PH.0; PH.1; PH.2; PH.3
- Pozidriv PZ.0; PZ.1; PZ.2; PZ.3
- Slotted 3; 4; 5.5; 6.5 mm
- Hex 3; 4; 5; 6; 7; 8; 10 mm
- Star T8; T10; T15; T20; T25; T27; T30; T40
- Star tamper T-8H; T-10H; T-15H; T-20H;
T-25H; T-27H; T-30H; T-40H

20 teeth ratchet handle

48 teeth T mini ratchet handle

Sliding T handle

Extension 2" & 4"

Flexible extension 145mml

Spinner

Universal joint

Magnetic socket pick-up

1/2" part

- 6pt. Flank socket
10; 11; 12; 13; 14; 15; 16; 17; 18; 19; 21; 22; 24; 27; 30; 32 mm
- 6pt. Flank deep socket
14; 15; 17; 19; 22; 24 mm
- Star socket
E12; E14; E16; E18; E20; E22; E24
- 36 teeth ratchet handle
Extension 5" & 10"
- Universal joint
- Adaptor for ext. 3/8"(F)x1/2"(M)
- Spark plug socket 16; 20.6mm
- Others:
- 10pc Hex ball point long key set
1.27; 1.5; 2; 2.5; 3; 4; 5; 6; 8; 10mm

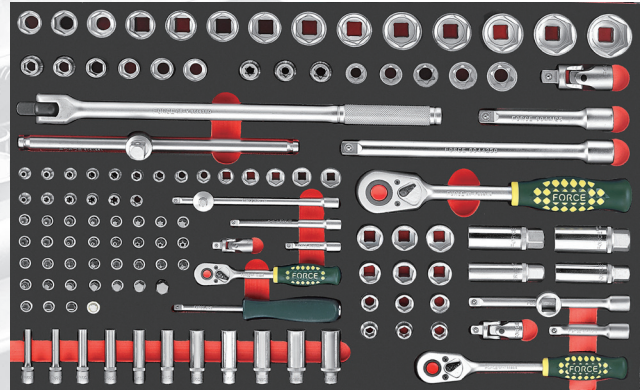

NO.41281

128pc 1/4" & 3/8" & 1/2" DR. Socket combination set

Contents: 1/4" & 3/8" & 1/2"DR.

1/4" part

- 6pt. Flank socket
3.2; 4; 4.5; 5; 5.5; 6; 7; 8; 9; 10; 11; 12; 13; 14 mm
- 6pt. Flank deep socket(50mml)
4; 5; 6; 7; 8; 9; 10; 11; 12; 13; 14 mm
- Star socket E4; E5; E6; E7; E8; E10
- Socket bit 32mml
- Hex 3; 4; 5; 6; 7; 8; 10 mm
- Phillips PH.0; PH.1; PH.2; PH.3
- Pozidriv PZ.0; PZ.1; PZ.2; PZ.3
- Slotted 4; 5.5; 6.5 mm
- Star T8; T10; T15; T20; T25; T27; T30; T40
- Star tamper T-8H; T-10H; T-15H; T-20H;
T-25H; T-27H; T-30H; T-40H

20 teeth ratchet handle

Extension 2" & 4" & 6"

Universal joint

Adaptor for ext. 3/8"(F)x1/4"(M)

Magnetic socket pick-up

Spinner

3/8"DR. Part

- 6pt. Flank socket
8; 9; 10; 11; 12; 13; 14; 15; 16; 17; 18; 19 mm
- 30 teeth ratchet handle
- Extension 3" & 6"
- Universal joint
- Adaptor for Extension 1/2"(F)x3/8"(M)
- Megnetic Spark plug socket 14; 16; 18; 20.6 mm

1/2"DR. Part

- 6pt. Flank socket
10; 11; 12; 13; 14; 15; 16; 17; 18; 19;
20; 21; 22; 23; 24; 26; 27; 28; 30; 32 mm
- Star socket
E11; E12; E14; E16; E18; E20; E22; E24
- 36 teeth ratchet handle
- Extension bar 5"; 10"
- Universal joint
- Swivel handle 380mml 15"
- 1-Sliding T handle 250mml

Socket Combination

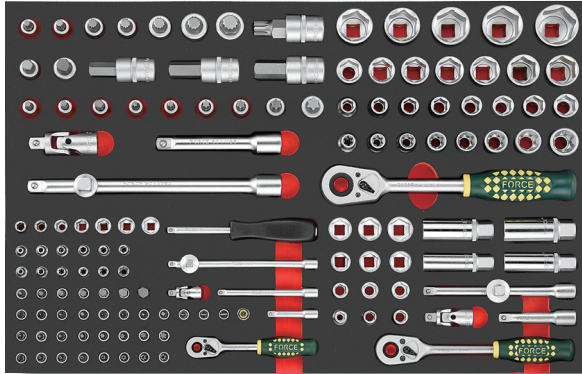

NO.41371

137pc 1/4" & 3/8" & 1/2" DR. Socket combination set

Contents: 1/4" & 3/8" & 1/2" DR.

1/4" part

● 6pt. Flank socket

3.2; 4; 4.5; 5; 5.5; 6; 7; 8; 9; 10; 11; 12; 13 mm

★ Star socket E4; E5; E6; E7; E8; E10

Socket bit 32mmL

○ Hex 3; 4; 5; 6; 7; 8; 10 mm

○ Phillips PH.0; PH.1; PH.2; PH.3

○ Pozidriv PZ.0; PZ.1; PZ.2; PZ.3

○ Slotted 4; 5.5; 6.5 mm

★ Star T8; T10; T15; T20; T25; T27; T30; T40

★ Star tamper T-8H; T-10H; T-15H; T-20H; T-25H; T-27H; T-30H; T-40H

20 teeth ratchet handle

Extension 2" & 4" & 6"

Universal joint

Adaptor for ext. 3/8"(F)x1/4"(M)

Magnetic socket pick-up

Spinner

3/8" DR. Part

● 6pt. Flank socket

8; 9; 10; 11; 12; 13; 14; 15; 16; 17; 18; 19 mm

30 teeth ratchet handle

2-Extension 3" & 6"

Universal joint

Adaptor for Extension 1/2"(F)x3/8"(M)

● Magnetic Spark plug socket 14; 16; 18; 20.6 mm

1/2" DR. Part

● 6pt. Flank socket

10; 11; 12; 13; 14; 15; 16; 17; 18; 19;

20; 21; 22; 23; 24; 26; 27; 28; 30; 32 mm

★ Star socket

E11; E12; E14; E16; E18; E20; E22; E24

1/2" socket bit

○ Hex 5; 6; 8; 10; 12 mm (55mmL)

○ Hex 14mm (65mmL)

○ Hex 17; 19 mm (70mmL)

★ Star T30; T40; T45; T50; T55; T60 (55mmL)

○ Spline M6; M8; M9 M10; M12; M14; M16 (55mmL)

○ Spline M18 (70mmL)

36 teeth ratchet handle

Extension bar 5"; 10"

Universal joint

Adaptor for ext. 3/8"(F)x1/2"(M)

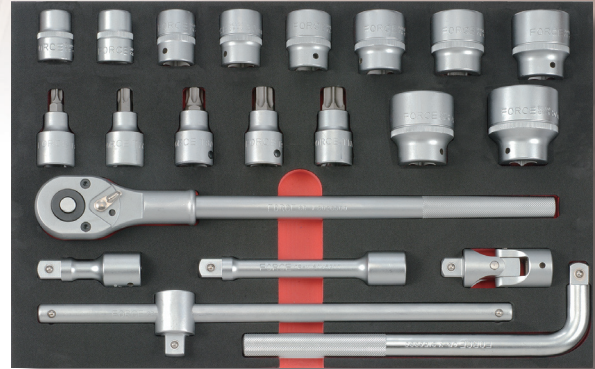

NO.6215

21pc 3/4" DR. Socket combination set

● 12pt. Flank socket

22; 24; 27; 30; 32; 36; 38; 41; 46; 50 mm

Star socket bit (80mmL) T60; T70; T80; T90; T100

Ratchet handle 500mmL

Sliding T bar 450mmL

Extension 100; 200 mmL

Universal joint

L handle 330mmL



NO.6232

23pc 3/4" DR. Socket combination set

● 12pt. Flank socket

19; 21; 22; 24; 27; 30; 32; 33; 34; 35; 36; 38; 41; 46 mm

○ Hex socket bit (80mmL) 14; 17; 19; 22 mm

Ratchet handle 500mmL

Sliding T bar 450mmL

Extension 100; 200 mmL

Universal joint

Socket Combination

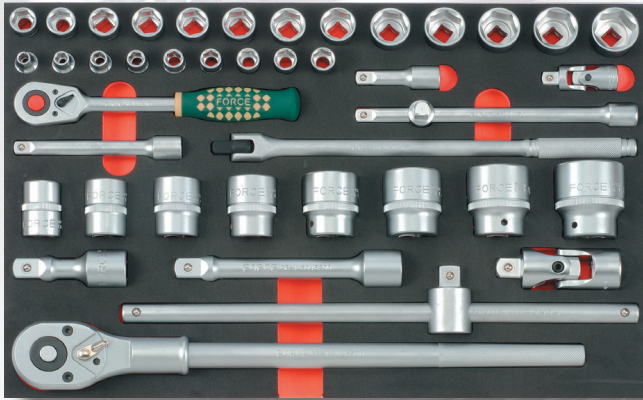

NO.6421

42pc 1/2" & 3/4" DR. Socket combination

Contents: 1/2"DR. & 3/4" DR.

1/2"DR. part

- 6pt. Flank socket
8; 9; 10; 11; 12; 13; 14; 15; 16; 17; 18; 19;
20; 21; 22; 23; 24; 26; 27; 28; 30; 32 mm
 - Ratchet handle
 - Swivel handle 15"
 - Extension 75; 150; 250 mmL
 - Universal joint
 - Adaptor for Extension 3/8"(F) x 1/2"(M)
- 3/4"DR. part
- 12pt. Flank socket
24; 27; 30; 32; 36; 38; 41; 46 mm
 - Ratchet handle 500mmL
 - Extension 100; 200 mmL
 - Sliding T bar 450mmL
 - Universal joint

Torx and five-sided star

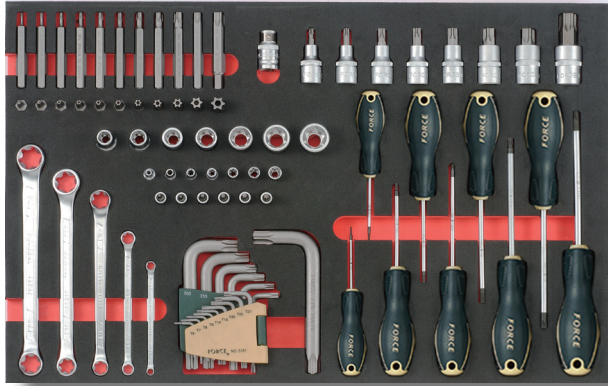

NO.4811

81pc Star set

Content: 1/4" & 1/2" DR.

1/4" part

- Star socket E4 ; E5 ; E6 ; E7 ; E8 ; E10 ; E11
- Star socket bit T8 ; T10 ; T15 ; T20 ; T25 ; T27

1/2" part

- Star socket E12 ; E14 ; E16 ; E18 ; E20 ; E22 ; E24
- Star socket bit T30 ; T40 ; T45 ; T50 ; T55 ; T60 ; T70 (55mmL)
- Star socket bit T80 (70mmL)
- Bit holder 1/2"DR.x10mm
- 10mm Star bit
T10 ; T15 ; T20 ; T25 ; T27 ; T30 ; T40 ; T45 ; T50 ; T55 ; T60 (75mmL)
- 10mm Star tamperproof bit
T-10H ; T-15H ; T-20H ; T-25H ; T-27H ; T-30H ;
T-40H ; T-45H ; T-50H ; T-55H ; T-60H (30mmL)

Others

- Star tamperproof screwdriver
T-6H ; T-8H ; T-10H ; T-15H ; T-20H ; T-25H ; T-27H ; T-30H ; T-40H
- Star key set
T6 ; T7 ; T8 ; T9 ; T10 ; T15 ; T20 ; T25 ;
T27 ; T30 ; T40 ; T45 ; T50 ; T55 ; T60
- Star key T70
- Star spanner
E6xE8 ; E10xE12 ; E14xE18 ; E16xE22 ; E20xE24

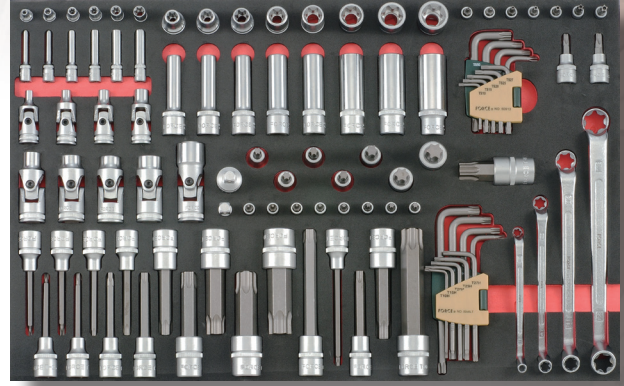

NO.41041

104pc Star & Five-sided star set

Contents: 1/4" & 3/8" & 1/2" DR.

1/4" DR. Part

- Star socket E4 ; E5 ; E6 ; E7 ; E8 ; E10
- Star deep socket (50mmL) E4 ; E5 ; E6 ; E7 ; E8 ; E10
- Star socket bit T8 ; T9 ; T10 ; T15 ; T20 ; T25 ; T27 ; T30

- Five-sided star tamper socket bit
TS10 ; TS15 ; TS20 ; TS25 ; TS27 ; TS30 ; TS40

Adapter 1/4"(F) - 3/8"(M)

3/8" DR. Part

- Five-sided star tamper socket bit TS45 ; TS50

- Star universal socket E6 ; E8 ; E10 ; E12

1/2" DR. Part

- Star socket
E11 ; E12 ; E14 ; E16 ; E18 ; E20 ; E22 ; E24
- Star deep socket (77mmL)
E11 ; E12 ; E14 ; E16 ; E18 ; E20 ; E22 ; E24
- Star socket bit (55mmL) T40 ; T45 ; T47 ; T50 ; T55 ; T60 ; T70
- Star socket bit (70mmL) T80
- Star socket bit (100mmL)
T20 ; T25 ; T27 ; T30 ; T40 ; T45 ; T50 ; T55 ; T60 ; T70 ; T80 ; T90 ; T100
- Star socket bit (140mmL) T60
- Star tamperproof socket bit (100mmL) T-55H
- Star tamperproof socket bit (105mmL) T-70H
- Star tamperproof socket bit (130mmL) T-30H
- Star tamperproof socket bit (140mmL) T-80H
- Star universal socket E14 ; E16 ; E18 ; E20 ; E24

Others

- Star 75° offset wrench E6xE8 ; E10xE12 ; E14xE18 ; E20xE24
- Star tamper long key set
T-10H ; T-15H ; T-20H ; T-25H ; T-27H ;
T-30H ; T-40H ; T-45H ; T-50H
- Five-sided star tamper L key set
TS10 ; TS15 ; TS20 ; TS25 ; TS27 ;
TS30 ; TS40 ; TS45 ; TS50

T handle & grip key

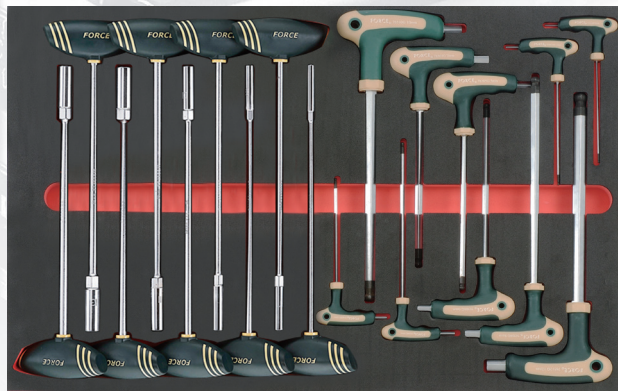

NO.2195

19pc Hex-ball grip key and Hex nut T handle set

- ⊗ ○ L hex ball key grips wrench
2; 2.5; 3; 4; 5; 6; 7; 8; 10; 12 mm
- T handle nut driver
5, 6, 7, 8, 9, 10, 11, 12, 13 (300mmL)

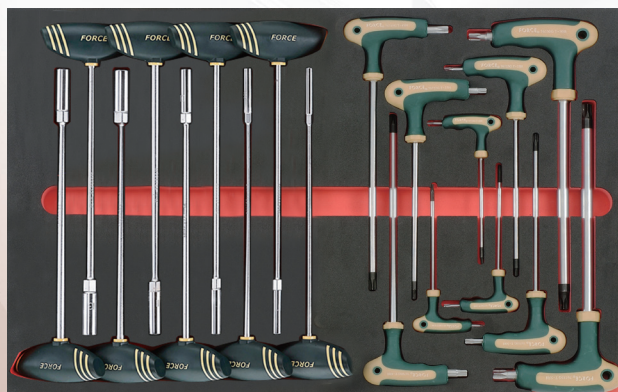

NO.2196

19pc Star tamperproof grip key and Star nut T handle set

- ⊗ Star tamperproof grip key
T-10H; T-15H; T-20H; T-25H; T-27H;
T-30H; T-40H; T-45H; T-50H; T-55H
- T handle star nut driver
E4, E5, E6, E7, E8, E10, E12, E14, E16 (300mmL)

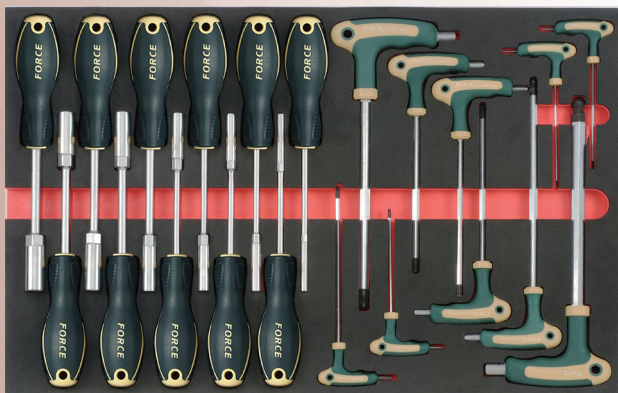

NO.2212

21pc Hex nut driver and Hex-ball grip key set

- Hex nut driver
4; 5; 6; 7; 8; 9; 10; 11; 12; 13; 14 mm
- ⊗ ○ Hex & Hex-ball grip key
2; 2.5; 3; 4; 5; 6; 7; 8; 10; 12 mm

Wrench & Spanner

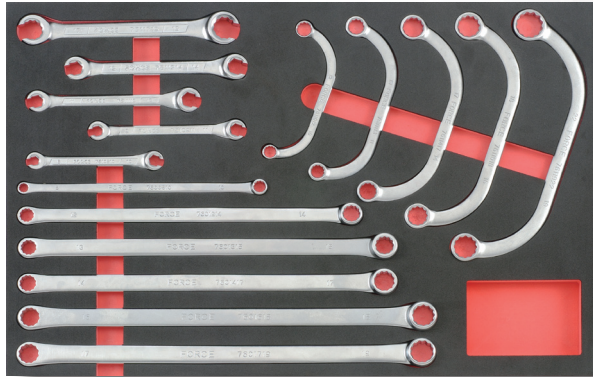

NO.5168

16pc Automotive special wrench set

- Flare nut wrench
8x10; 9x11; 11x13; 12x14; 17x19 mm
- Extra long flat ring wrench
8x10; 12x14; 13x15; 14x17; 16x18; 17x19 mm
- Half-moon ring wrench
10x12; 11x13; 14x17; 16x18; 19x22 mm

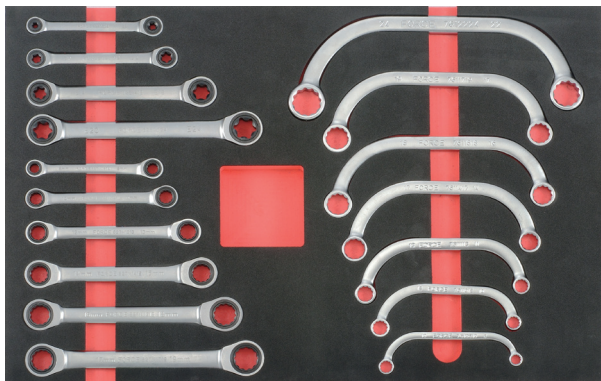

NO.5177

17pc Gear wrench & half-moon wrench set

- Half-moon ring wrench
8x10; 10x12; 11x13; 14x17; 16x18; 17x19; 22x24 mm
- Double gear flat wrench
8x9; 10x11; 12x13; 14x15; 16x18; 17x19 mm
- ★ Star double gear flat wrench
E6xE8; E10xE12; E14xE18; E20xE24

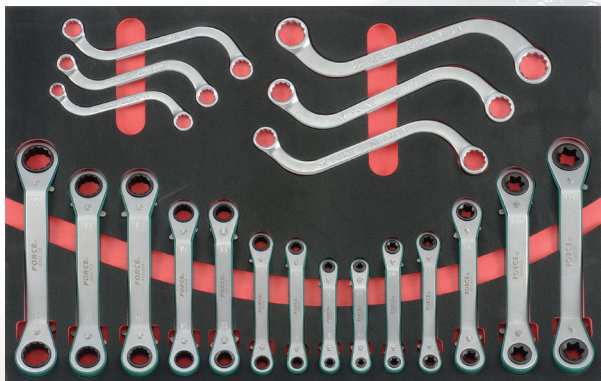

NO.5208

20pc Wrench set

- S-form ring wrench
10x12; 11x13; 14x15; 16x18; 17x19; 22x24 mm
- 15° Offset ratchet ring wrench
6x7; 8x9; 10x11; 12x13; 14x15; 16x18; 17x19; 21x22 mm
- ★ 15° Offset star ratchet ring wrench
E6xE7; E8xE10; E11xE12; E14xE16; E18xE20; E22xE24

Wrench & Spanner

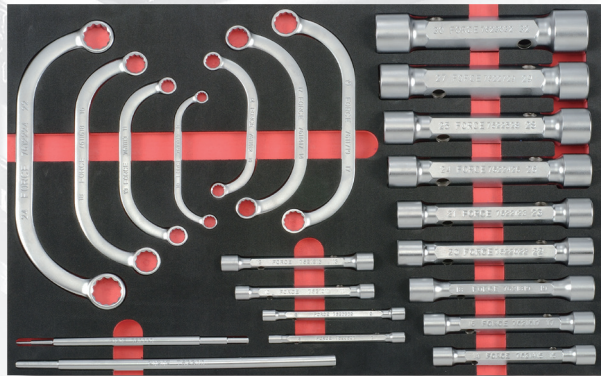

NO.5223

22pc Half-moon wrench & double ended socket wrench set

- Half-moon ring wrench
8x10; 10x12; 11x13; 14x17; 16x18; 17x19; 22x24 mm
- Double ended socket wrench
6x7; 8x9; 10x11; 12x13; 14x15; 16x17; 18x19;
20x22; 21x23; 24x26; 25x28; 27x29; 30x32 mm
Bar 220mmL(for size 0607 to 2123);
300mmL(for size 2426 to 3032)

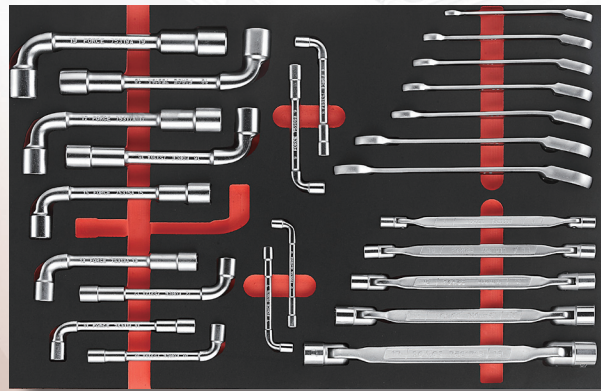

NO.5263

26pc Wrench set

- Angle wrench 12pt.-6pt.
6; 7; 8; 9; 10; 11; 12; 13; 14; 15; 16; 17; 18; 19 mm
- Hinged socket wrench
8x9; 10x11; 12x13; 14x15; 17x19 mm
- Reversible gear wrench
8; 10; 12; 13; 14; 17; 19mm



NO.5271

27pc Flexible gear wrench & double ended socket wrench set

- Flexible gear wrench
8; 9; 10; 11; 12; 13; 14; 15; 16; 17; 18; 19 mm
- Double ended socket wrench
6x7; 8x9; 10x11; 12x13; 14x15; 16x17; 18x19;
20x22; 21x23; 24x26; 25x28; 27x29; 30x32 mm
Bar 220mmL(for size 0607 to 2123);
300mmL(for size 2426 to 3032)

Wrench & Spanner



NO.5283

28pc Wrench set

- Flare nut wrench
8x10; 11x13; 12x14; 16x18; 17x19; 19x22 mm
- Hinged socket wrench
6x7; 8x9; 10x11; 12x13; 14x15; 16x17;
18x19; 20x22; 21x23; 24x27 mm
- Flat gear wrench
8; 9; 10; 11; 12; 13; 14; 15; 16; 17; 18; 19 mm



NO.5291

29pc Automotive special wrench set

- Ratchet flare nut wrench
8; 10; 11; 12; 13; 14; 17; 19; 22 mm
- Midjet combination wrench
8; 10; 11; 12; 13; 14; 17; 19 mm
- Torx spanner
E6xE8 ; E10xE12 ; E14xE18 ; E16xE22; E20xE24
- Extra long flat ring wrench
8x10; 12x14; 13x15; 14x17; 16x18; 17x19; 22x24 mm

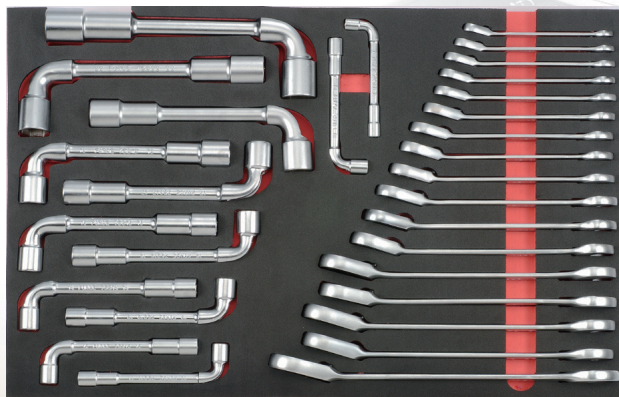

NO.5302

30pc Angle wrench & Reversible gear wrench set

- Angle wrench 6pt.-6pt.
8; 10; 11; 12; 13; 14; 15; 16; 17; 18; 19; 22; 24 mm
- Reversible gear wrench
8; 9; 10; 11; 12; 13; 14; 15; 16; 17; 18; 19; 20; 21; 22; 23; 24 mm

Wrench & Spanner

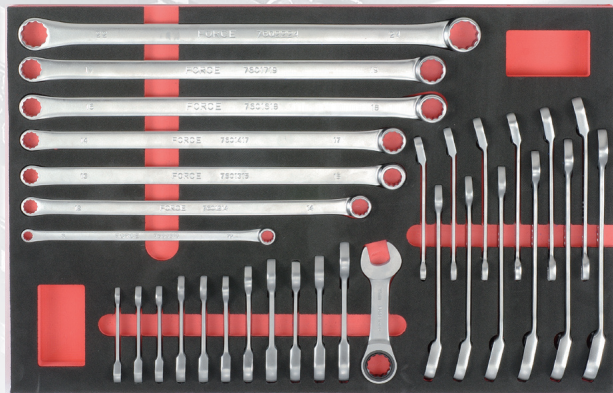

NO.5311

31pc Gear wrench set

- Reversible gear wrench
8; 9; 10; 11; 12; 13; 14; 15; 16; 17; 18; 19 mm
- Stubby flat gear wrench
8; 9; 10; 11; 12; 13; 14; 15; 16; 17; 18; 19 mm
- Extra long flat ring wrench
8x10; 12x14; 13x15; 14x17; 16x18; 17x19; 22x24 mm

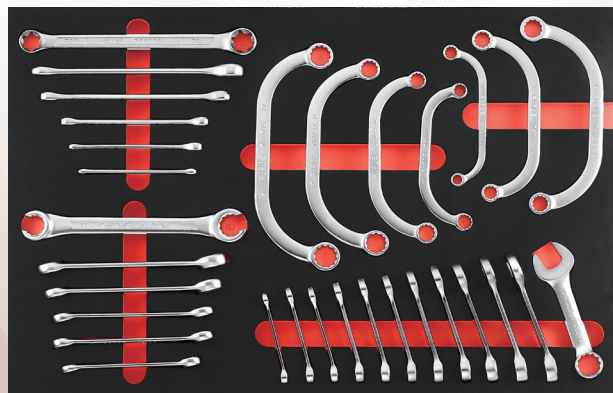

NO.5312

31pc Special wrench set

- Midget combination wrench
8; 9; 10; 11; 12; 13; 14; 15; 16; 17; 18; 19 mm
- Flare nut wrench
8x10; 9x11; 10x12; 11x13; 12x14; 17x19mm
- Star wrench
E6xE8; E7xE11; E10xE12; E14xE18; E16xE22; E20xE24
- Half-moon ring wrench
8x10; 10x12; 11x13; 12x14; 13x15; 14x17; 17x19 mm

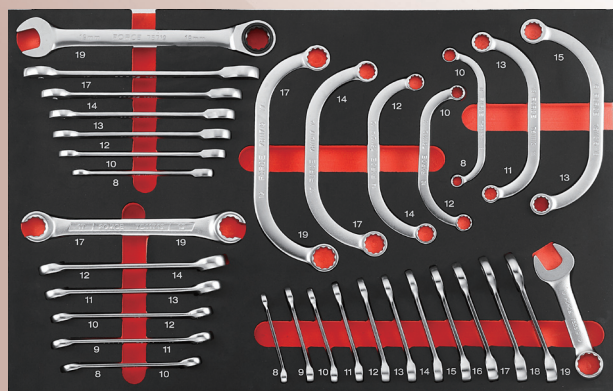

NO.5322

32pc Special wrench set

- Midget combination wrench
8; 9; 10; 11; 12; 13; 14; 15; 16; 17; 18; 19 mm
- Flare nut wrench
8x10; 9x11; 10x12; 11x13; 12x14; 17x19mm
- Ring flat gear wrench
8; 10; 12; 13; 14; 17; 19mm
- Half-moon ring wrench
8x10; 10x12; 11x13; 12x14; 13x15; 14x17; 17x19 mm

Wrench & Spanner



NO.5332

33pc Automotive essential wrench set

Flare nut wrench
8x10; 11x13; 12x14; 16x18; 17x19; 19x22; 24x27 mm
Combination wrench
6; 7; 8; 9; 10; 11; 12; 13; 14; 15; 16; 17; 18; 19; 21; 22; 24 mm
75° Offset ring wrench
6x7; 8x9; 10x11; 12x13; 14x15; 16x17; 18x19; 21x23; 22x24 mm

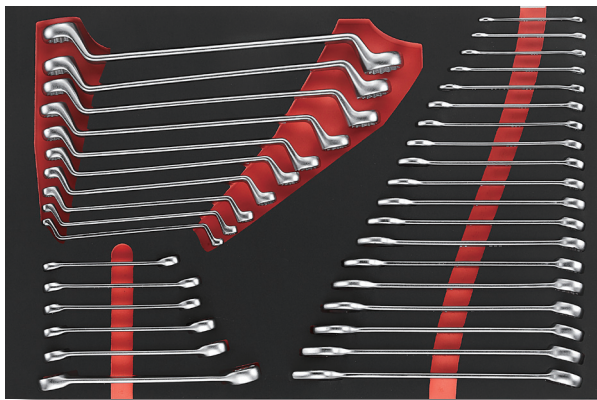

NO.5353

35pc Wrench set

Combination wrench
6; 7; 8; 9; 10; 11; 12; 13; 14; 15; 16; 17; 18; 19; 20; 21; 22; 23; 24 mm
75° Offset ring wrench
6x7; 8x9; 10x11; 12x13; 14x15; 16x17; 18x19; 20x22; 21x23; 24x27 mm
Flare nut wrench
8x10; 9x11; 10x12; 11x13; 12x14; 17x19mm



NO.5361

36pc Spanner set

Combination wrench
6; 7; 8; 9; 10; 11; 12; 13; 14; 15; 16; 17; 18; 19; 21; 22; 23; 24; 26; 27; 28; 30; 32 mm
75° Offset ring wrench
6x7; 8x9; 10x11; 12x13; 14x15; 16x17; 18x19; 21x23; 20x22; 23x26; 24x27; 25x28; 30x32 mm

Wrench & Spanner



NO.5362

36pc Essential wrench set

Double open end wrench
6x7; 8x9; 10x11; 12x13; 14x15; 16x17;
18x19; 20x22; 21x23; 24x27 mm
Combination wrench
8; 10; 11; 12; 13; 14; 15; 16; 17; 19; 22; 24; 27; 30; 32 mm
75° offset ring wrench
6x7; 8x9; 10x11; 12x13; 14x15; 16x17; 18x19;
20x22; 21x23; 24x27; 30x32 mm

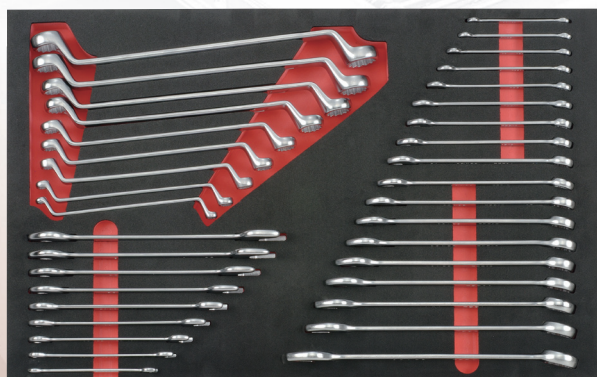

NO.5363

36pc Automotive essential wrench set

Double open end wrench
6x7; 8x9; 10x11; 12x13; 14x15; 16x17; 18x19; 20x22; 21x23 mm
Combination wrench
6; 7; 8; 9; 10; 11; 12; 13; 14; 15; 16; 17; 18; 19; 20; 21; 22; 24 mm
75° offset ring wrench
6x7; 8x9; 10x11; 12x13; 14x15; 16x17; 18x19; 20x22; 21x23 mm

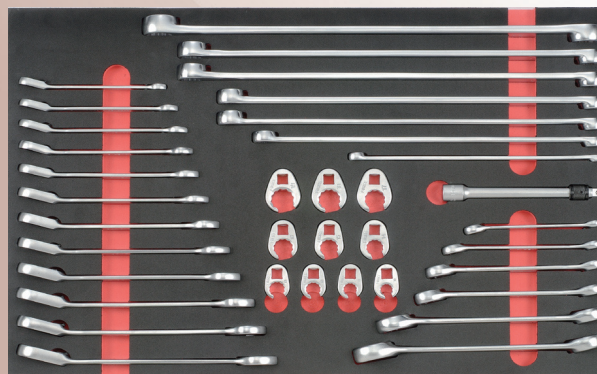

NO.5365

36pc Automotive special wrench set

Flare nut wrench
8x10; 9x11; 11x13; 12x14; 17x19; 19x22 mm
3/8"DR. 12pt. Crowfoot flare nut wrench
10; 11; 12; 13; 14; 15; 16; 17; 18; 19 mm
Reversible gear wrench
8; 9; 10; 11; 12; 13; 14; 15; 16; 17; 18; 19 mm
Extra long flat ring wrench
8x10; 12x14; 13x15; 14x17; 16x18; 17x19; 22x24 mm
3/8"DR. Locking extension 150mmL

Wrench & Spanner

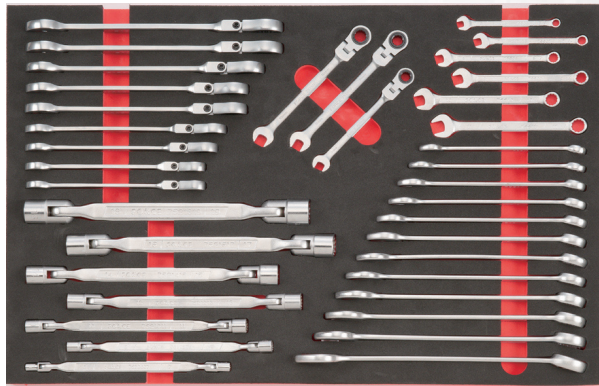

NO.5371

37pc Automotive essential wrench set

- Reversible gear wrench
8; 9; 10; 11; 12; 13; 14; 15; 16; 17; 18; 19 mm
- Combination wrench
6; 7; 8; 9; 10; 11; 12; 13; 14; 15; 16; 17; 18; 19; 20; 21; 22; 24 mm
- Hinged socket wrench
6x7; 8x9; 10x11; 12x13; 14x15; 16x17; 18x19; mm



NO.5372

37pc Wrench set

- Combination wrench
6; 7; 8; 9; 10; 11; 12; 13; 14; 15; 16; 17; 18; 19; 20; 21; 22; 23; 24 mm
- Reversible gear wrench
8; 9; 10; 11; 12; 13; 14; 15; 16; 17; 18; 19 mm
- Gear wrench holder
10mm-1/4"sq.; 13mm-3/8"sq.; 19mm-1/2"sq.
- Gear wrench bit holder 10mm-1/4"hex
- Adjustable gauged wrench (left-threaded) 150; 300 mml

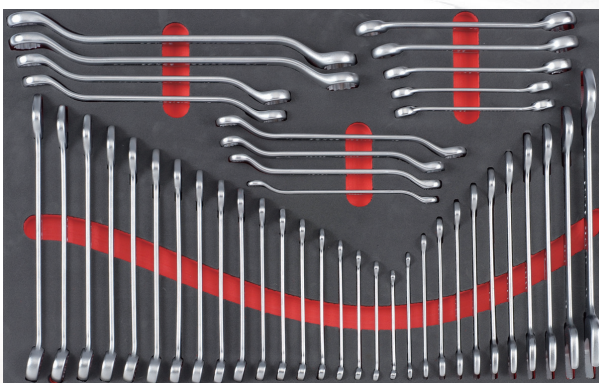

NO.5421

42pc Spanner set

- 45 degree offset ring wrench
8x9; 10x11; 12x13; 14x15; 16x17;
18x19; 21x23; 22x24 mm
- Double open end wrench
6x7; 8x9; 10x11; 12x13; 14x15; 16x17; 18x19;
20x22; 21x23; 24x27; 30x32 mm
- Combination wrench
6; 7; 8; 9; 10; 11; 12; 13; 14; 15;
16; 17; 18; 19; 20; 21; 22; 23 mm
- Flare nut wrench
9x11; 10x12; 12x14; 14x17; 17x19 mm

Pliers



NO.5117

11pc Pliers set

- Adjustable gauged wrench 10"
- Waterpump pliers 10"
- Locking pliers 10"
- Long nose straight pliers 11"
- Long nose 45 de. pliers 11"
- Long nose 90 de. pliers 11"
- Multi-purpose 4 points gripping pliers 11"
- Long nose pliers 8"
- Combination pliers 7"
- Diagonal pliers 7"
- Slip joint pliers 8.5"

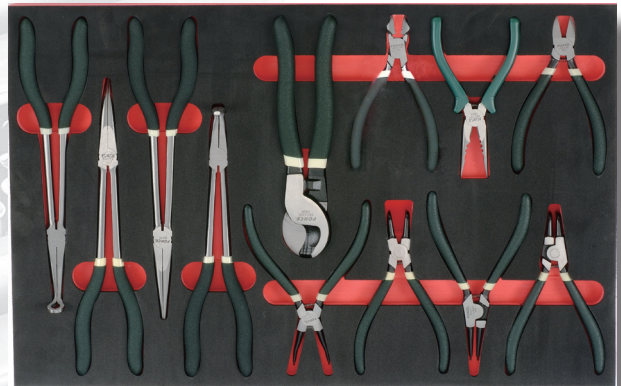

NO.51228

12pc Pliers set

- Long nose straight pliers 11"
- Long nose 45 de. pliers 11"
- Long nose 90 de. pliers 11"
- Multi-purpose 4 points gripping pliers 11"
- Circlip pliers
- External straight tip 1.8mm for opening
- Internal straight tip 1.8mm for closing
- External 90° bent tip 1.8mm for opening
- Internal 90° bent tip 1.8mm for closing
- 4-in-1 Electrical pliers 6"
- Diagonal cutting pliers 6"
- Cable cutter 10"
- Plastic cutting pliers 6"

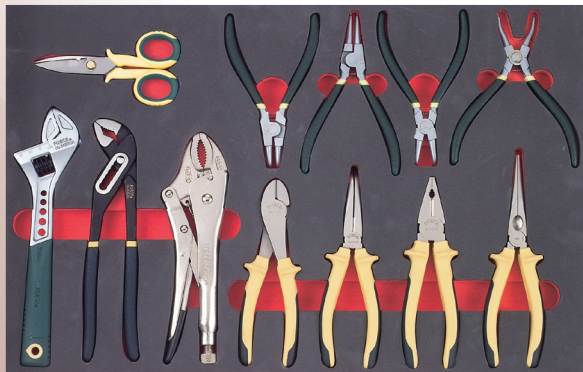

NO.51217

12pc Pliers set

- Contents:
- Long nose pliers 8"
 - Bent long nose pliers 8"
 - Combination pliers 7"
 - Diagonal pliers 7"
 - Locking pliers 10"
 - Waterpump pliers 10"
 - Snap ring pliers
 - External straight tip 1.8mm (open)
 - Internal straight tip 1.8mm (close)
 - External 90° bent tip 1.8mm (open)
 - Internal 90° bent tip 1.8mm (close)
 - Adjustable gauged wrench 10"
 - Technician's scissors 145mmL



NO.51311

13pc Pliers set

- Long nose pliers 8"
- Combination pliers 7"
- Diagonal pliers 7"
- Locking pliers 10"
- Waterpump pliers 10"
- Heavy duty stripper pliers
- Wire rope cutter 7"
- Snap ring pliers
- External straight tip 1.8mm (open)
- Internal straight tip 1.8mm (close)
- External 90° bent tip 1.8mm (open)
- Internal 90° bent tip 1.8mm (close)
- Adjustable gauged wrench 10"
- Technician's scissors 145mmL

Pliers



NO.5147
14pc Plier set

- Long Nose pliers 8"
- Bent long Nose pliers 8"
- Mini nose pliers
- Diagonal pliers 6.3"
- Mini diagonal pliers
- Waterpump pliers 10"
- Locking pliers 5"; 10"
- Long nose locking pliers 6"
- Cable cutter 160mmL
- Multi-purpose crimping tool
- Aviation tin snips Left cut
- Aviation tin snips Right cut
- Utility Knife (incl. 3pc blades)

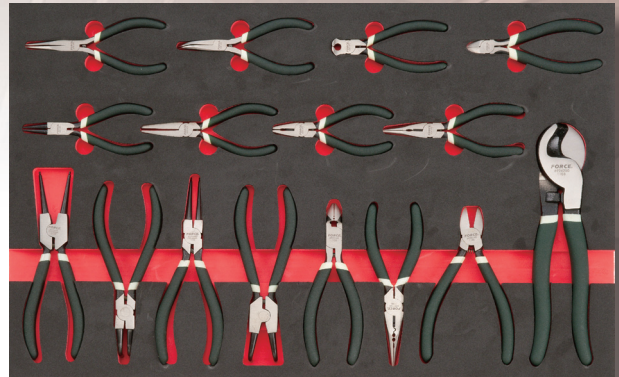

NO.51610
16pc Pliers set

- Round nose pliers 6"
- Flat nose pliers 5"
- Combination pliers 5"
- Long nose pliers 5"
- Needle nose pliers 6"
- Bent nose pliers 6"
- Cutter pliers 6"
- Diagonal pliers 6"
- Circlip pliers
- External straight tip 1.8mm for opening
- Internal straight tip 1.8mm for closing
- External 90° Bent tip 1.8mm for opening
- Internal 90° bent tip 1.8mm for closing
- 4-in-1 Electrical pliers 6"
- Diagonal cutting pliers 6"
- Cable cutter 10"
- Plastic cutting pliers 6"



NO.5155
15pc Pliers and hammer set

- Ribbed chisel 26mm (200mmL)
- Pin punch 4mm (190mmL); 6mm (210mmL)
- Center punch 4mm (185mmL)
- Snap ring pliers
- Internal 90° bent tip 1.8mm (close)
- External 90° bent tip 1.8mm (open)
- Internal straight tip 1.8mm (close)
- External straight tip 1.8mm (open)
- Long nose pliers 8"
- Combination pliers 7"
- Diagonal pliers 7"
- Waterpump pliers 10"
- Locking pliers 10"
- Soft face hammer 400gw
- Riveting hammer 32mm

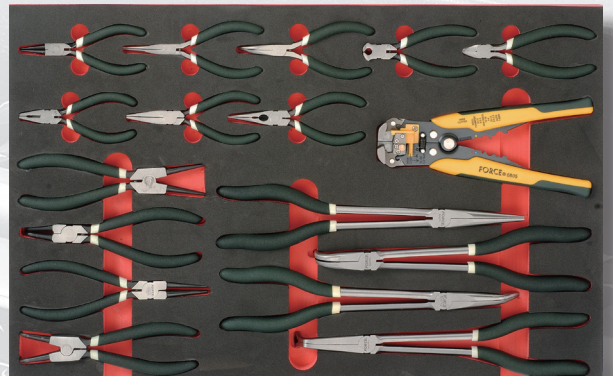

NO.5178
17pc Pliers set

- Long nose straight pliers 11"
- Long nose 45 de. pliers 11"
- Long nose 90 de. pliers 11"
- Multi-purpose 4 points gripping pliers 11"
- Round nose pliers 5"
- Flat nose pliers 5"
- Combination pliers 5"
- Long nose pliers 5"
- Needle nose pliers 6"
- Bent nose pliers 6"
- Cutter pliers 6"
- Diagonal pliers 6"
- Snap ring pliers
- Internal 90° bent tip 1.8mm (close)
- External 90° bent tip 1.8mm (open)
- Internal straight tip 1.8mm (close)
- External straight tip 1.8mm (open)
- Heavy duty stripper pliers

Utility Tools

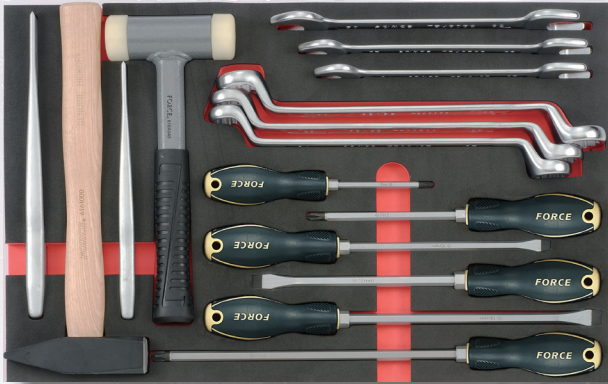

NO.5169

16pc Truck wrench, chisel & screwdriver set

- Engineer hammer 1000g
- Ribbed (Cold) chisel 29mm (250mml); 34mm (300mml)
- Recoilless hammer \varnothing 45mm
- ⊕ Hammer Phillips screwdrivers PH.2 (100mml); PH.3 (150mml)
- ⊕ Hammer Phillips screwdrivers PH.4 (300mml)
- Hammer slotted screwdriver 10; 12; 14 mm
- Double open end wrench 24x27; 25x28; 30x32 mm
- 75° offset ring wrench 24x27; 25x28; 30x32 mm

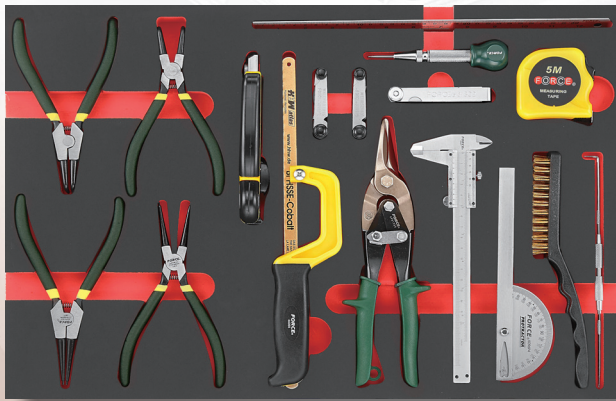

NO.5179

17pc Utility set

- Utility Knife (incl. 2pc blades)
- Snap ring pliers (straight-open) 180mm
- Snap ring pliers (straight-close) 180mm
- Snap ring pliers (bent-open) 180mm
- Snap ring pliers (bent-close) 180mm
- Stainless steel vernier caliper
- Auto center punch
- Stainless steel straight rule 30cm
- Stainless steel protractor
- Screw pitch gauges 0.25-6 (Metric)
- Screw pitch gauges 4-62 (SAE)
- Steel scriber
- 5m measuring tape
- 26 sizes Feeler gauges (SAE & Metric)
- Hacksaw 315mml
- Aviation tin snips - straight cut
- Wire brush



NO.5186

18pc Utility set

- Utility knife (incl. 2pc blades)
- 8" Flat file
- 8" Half round file
- 8" Round file
- 8" Square file
- 8" Triangular file
- Stainless steel vernier caliper
- Auto center punch
- Stainless steel straight rule 30cm
- Stainless steel protractor
- Screw pitch gauges 0.25-6 (Metric)
- Screw pitch gauges 4-62 (SAE)
- Steel scriber
- 5m measuring tape
- 26 sizes Feeler gauges (SAE & Metric)
- Hacksaw 315mml
- Aviation tin snips - straight cut
- Wire brush

Utility Tools

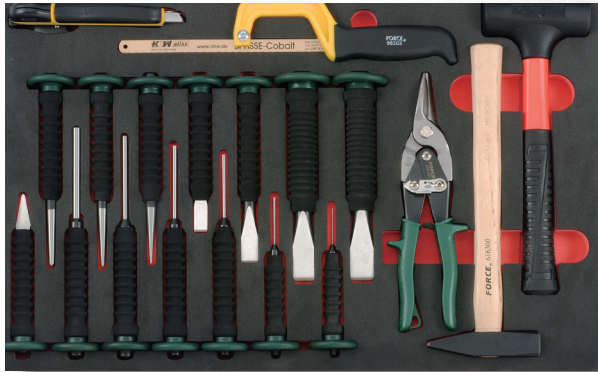

NO.5195

19pc Hammer & chisel set

- Engineer hammer 300g
- Rubber hammer 400g
- Quakeproof and safe chisel
12(150mmL); 15(180mmL); 19(200mmL); 22(200mmL)
- Quakeproof and safe cape chisel 150mmL
- Quakeproof and safe pin punch
2(140mmL); 3(150mmL); 4(190mmL);
5(200mmL); 6(210mmL); 8(215mmL)
- Quakeproof and safe center punch 2.5; 4; 6 (185mmL)
- Utility knife (incl. 3pc spare blades)
- Hacksaw 315mmL
- Aviation tin snips - straight cut



NO.5207

20pc Pliers & chisel set

- Locking pliers 10"
- Engineer hammer 300gw
- Rubber hammer 400gw
- Adjustable gauged wrench (250mmL)
- Chisel 12(150mmL); 15(180mmL); 19(200mmL)
- Ribbed flat chisel 26(200mmL)
- Pin punch
4mm (190mmL); 5mm (200mmL); 6mm (210mmL); 8mm (215mmL)
- Center punch 2.5mm (185mmL); 4mm (185mmL); 6mm (185mmL)
- Long nose pliers 8"
- Bent long nose pliers 8"
- Combination pliers 7"
- Diagonal pliers 7"
- Waterpump pliers 10"



NO.5207A

20pc Pliers & chisel set

- Locking pliers 10"
- Engineer hammer 300gw
- Soft face hammer 400gw (PU+Nylon)
- Adjustable gauged wrench (250mmL)
- Chisel 12(150mmL); 15(180mmL); 19(200mmL)
- Ribbed flat chisel 26(200mmL)
- Pin punch
4mm (190mmL); 5mm (200mmL);
6mm (210mmL); 8mm (215mmL)
- Center punch 2.5mm (185mmL); 4mm (185mmL); 6mm (185mmL)
- Long Nose pliers 8"
- Bent long Nose pliers 8"
- Combination pliers 7"
- Diagonal pliers 7"
- waterpump pliers 10"

Utility Tools



NO.5212

21pc Utility set

- Utility knife (3pcs blade incl.)
- 5m measuring tape
- Chisel 12mm (150mml)
- Ribbed chisel 21mm (150mml); 26mm (200mml)
- Cape chisel (150mml)
- Pin punch 2mm (140mml); 3mm (150mml); 4mm (190mml)
5mm (200mml); 6mm (210mml); 8mm (215mml)
- Tape punch 3mm (185mml)
- Center pinch 4(185mml)
- Engineer hammer 300gw
- Rubber hammer 400gw
- 3-in-1 Magnetic flexible pickup tool
- 26 sizes Feeler gauges (SAE & Metric)
- LED white light, clip-type (360° rotation)
- Technician's scissors 145mml
- Gasket scraper



NO.5232

23pc Utility set

- Engineer hammer 300gw
- Chisel 12(150mml); 15(180mml); 19(200mml); 22(200mml)
- Pin punch
2(140mml); 3(150mml); 4(190mml); 5(200mml);
6(210mml); 8(215mml); 10(230mml)
- Center punch 185mml 4
- Pry bar 16"
- Pry bar 16" (Bended head, Hexagonal shank)
- 8" Flat file
- 8" Half round file
- 8" Round file
- Pencil of wolfram steel
- 5m measuring tape
- Stainless steel vernier caliper
- Flexible magnet pick-up tool
- Multi-function magnetic pick-up



NO.56261

626pc Utility set

- 5/16" short bit
- ⊕ Phillips PH.2; PH.3 (36mml)
- ⊕ Pozidriv PZ.2; PZ.3 (36mml)
- ⊖ Slotted 9; 11mm (36mml)
- Hex 6; 8; 10mm (36mml)
- ⊕ Star T25; T30; T40; T45; T50 (35mml)
- 5/16" long bit
- ⊕ Phillips PH.2; PH.3 (80mml)
- ⊖ Slotted 9; 11mm (80mml)
- Bit adaptor 3/8" DR.x5/16"Hex
- Bit holder 1/2"DR.x5/16"
- Aluminum rivet 4x8
- Aluminum rivet 4x10
- Aluminum rivet 4.8x8
- Aluminum rivet 4.8x10
- Stainless rivet 4x7
- Stainless rivet 4x10
- Tie down pliers
- Tie tape 2.5x98mml
- Tie tape 3.2x140mml
- Tie tape 4.6x180mml
- Tie tape 4.8x220mml
- Two-way base plate
- Multi-Function magnetic
- Pick up
- 5pc Screw extractor set
7/64"; 9/64"; 5/32"; 1/4";
19/64"
- Rivet pliers
- Nut splitter
5/16"-1/2" (9-12mm)
1/2"-5/8" (12-16mm)
5/8"-7/8" (16-22mm)
- Impact driver
- Stud extractor 6; 8; 10; 12mm

Impact Tools



NO.4341

34pc 1/2" DR. Impact socket & Wheel nut tools

- 6pt. Flank impact socket
10; 11; 12; 13; 14; 15; 16; 17; 18; 19; 21; 22; 23; 24 mm
- 6pt. Flank impact deep socket
10; 12; 13; 14; 16; 17; 19; 21; 22; 24 mm
- Wheel nut 6pt. Flank impact socket (colored)
17; 19; 21; 22 mm
- Impact wrench
- Impact extension 5"
- Universal joint (ball type)
- 1/2" Torque wrench
- Foldable cross-handle socket wrench
17; 19; 21; 1/2" square (16"L; 400mml)
- Wheel balancing weight tool



NO.4531

53pc 1/2"DR. Impact socket combination set

- 6pt. Flank impact socket
10; 11; 12; 13; 14; 15; 16; 17; 18; 19;
21; 22; 23; 24; 26; 27; 30; 32 mm
- 6pt. Flank impact deep socket
12; 13; 14; 17; 19; 21; 22; 24; 27; 30; 32 mm
- Impact hex socket bit (one-piece)
4; 5; 6; 7; 8; 10; 12; 14; 17; 19 mm (60mml)
- Impact star socket bit (one-piece)
T20; T25; T27; T30; T40; T45; T50; T55; T60; T70 (60mml)
- Impact wrench
- Impact extension 3" & 5"
- Universal joint



NO.4573

57pc 1/2" DR. Impact socket combination set

- 6pt. Flank impact socket
10; 11; 12; 13; 14; 15; 16; 17; 18; 19; 21;
22; 23; 24; 26; 27; 30; 32; 33; 35; 36 mm
- 6pt. Flank impact deep socket
12; 13; 14; 17; 19; 21; 22; 24; 27; 30; 32; 36 mm
- Impact hex socket bit (one-piece)
4; 5; 6; 7; 8; 10; 12; 14; 17; 19 mm (60mml)
- Impact star socket bit (one-piece)
T20; T25; T27; T30; T40; T45; T50; T55; T60; T70 (60mml)
- Super duty impact ratchet wrench
- Impact wrench
- Impact extension 5"
- Universal joint (ball type)

Impact Tools



NO.4615

17pc Utility set

- 6pt. Flank impact socket
10; 12; 13; 14; 15; 16; 17; 18; 19; 21; 22; 24; 27; 30; 32; 36mm
- 6pt. Flank deep impact socket (85mml)
10; 12; 13; 14; 15; 16; 17; 18; 19; 21; 22; 24; 27; 30; 32; 36mm
- Colored wheel nut impact socket 17; 19; 21mm
- Thin-walled 6pt. Flank deep impact socket 17; 19; 21mm
- Impact extension (ball type) 5"; 10"
- Impact universal joint (ball type)
- Impact adapter (ball type)
3/8"(F)x1/2"(M); 3/4"(F)x1/2"(M)
- Hex impact socket bit (60mml)
5; 6; 8; 10; 12; 14; 17; 19mm
- Torx impact socket bit (60mml)
T30; T40; T45; T50; T55; T60; T70
- Spline impact socket bit (60mml)
M8; M10; M12



NO.6321

32pc 3/4"DR. Impact socket set

- 6pt. Flank impact socket
17; 19; 21; 22; 23; 24; 26; 27; 28; 29; 30; 32; 33; 34; 36 mm
- 6pt. Flank impact deep socket
17; 19; 21; 22; 23; 24; 26; 27; 28; 29; 30; 32; 33; 34; 36 mm
- Impact extension 10" (pin type)
- 1"DR. Adaptor (ball type) 1"(F)x3/4"(M);

Insulated Combination



NO.2182

18pc Insulated screwdriver & pliers set

- ⊕ Insulated Phillips screwdriver
PH.0(60mmL); PH.1(80mmL); PH.2(100mmL); PH.3(150mmL)
- ⊖ Insulated slotted screwdriver
2.5mm(75mmL); 3mm(100mmL); 3.5mm(100mmL);
4mm(100mmL); 5.5mm(125mmL); 6.5mm(150mmL);
8mm(175mmL)
- Insulated combination pliers 7"
- Insulated long nose pliers 8"
- Insulated diagonal pliers 8"
- Insulated wire stripper pliers 6"
- Insulated cable cutter 6"
- Multi-purpose crimping tool
- Universal voltage tester Testing range: 6~400V AC/DC



NO.3262

26pc 3/8"DR. Insulated socket set

- 12pt. Flank insulated socket
6; 7; 8; 9; 10; 11; 12; 13; 14; 15; 16; 17; 18; 19 mm
- Insulated combination wrench
7; 8; 10; 12; 14 mm
- Insulated extension 150, 250 mm
- Insulated ratchet handle
- Insulated T-handle
- Insulated torque wrench 5~25 Nm
- Insulated cable knife (straight)
- Insulated cable knife (curve)

1

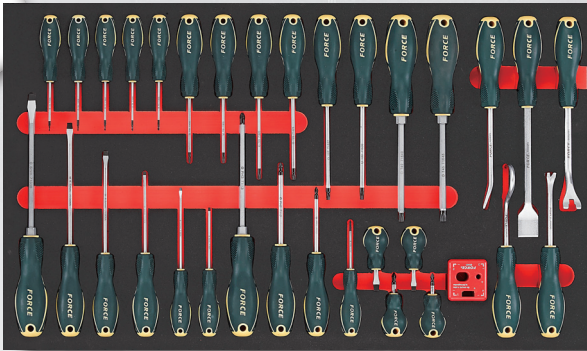

NO.2335

33pc Screwdriver set

- ⊕ Phillips screwdriver
PH.0x60mmL; PH.1x80mmL; PH.2x100mmL; PH.3x150mmL
- ⊕ Stubby Phillips screwdriver
PH.1x25mmL; PH.2x25mmL
- Slotted screwdriver
3mmx75mmL; 3.5mmx100mmL; 4mmx100mmL;
5.5mmx125mmL; 6.5mmx150mmL; 8mmx175mmL
- Stubby slotted screwdriver
5.5mmx25mmL; 6.5mmx25mmL
- ⊕ Star screwdriver
T5; T6; T7; T8; T9; T10; T15; T20; T25; T27; T30; T40; T45
Demagnetizer / Magnetizer
Trim pad remover (big)
Trim pad remover (small)
Gasket scraper
Radiator hose remover
Cotter pin puller

■ 10318-298

■ 10318B-298

■ 10318R-298

2

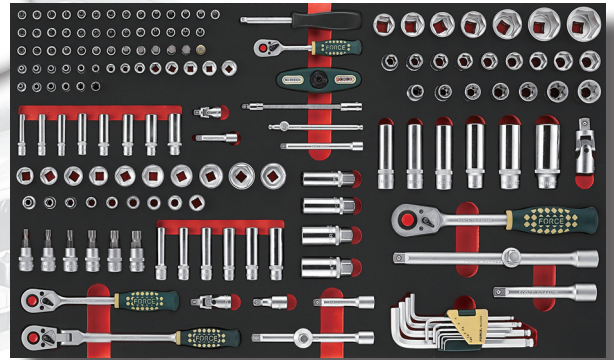

NO.41621

162pc 1/4", 3/8" & 1/2" DR. Socket combination set

Contents: 1/4" & 3/8" & 1/2"DR.

1/4" Part

- 6pt. Flank socket
3.2; 4; 4.5; 5; 5.5; 6; 7; 8; 9; 10; 11; 12; 13; 14 mm
- 6pt. Flank deep socket (50mmL)
6; 7; 8; 9; 10; 11; 12; 13 mm
- ⊕ Star socket E4; E5; E6; E7; E8; E10
Socket bit (32mmL)
- ⊕ Phillips PH.0; PH.1; PH.2; PH.3
- ⊕ Pozidriv PZ.0; PZ.1; PZ.2; PZ.3
- Slotted 3; 4; 5.5; 6.5 mm
- Hex 3; 4; 5; 6; 7; 8; 9; 10 mm
- ⊕ Star T8; T9; T10; T15; T20; T25; T27; T30; T35; T40
- ⊕ Star tamperproof T-8H; T-10H; T-15H; T-20H;
T-25H; T-27H; T-30H; T-35H; T-40H

20 teeth ratchet handle

48 teeth T mini ratchet handle

Sliding T handle

Extension 2" & 4"

Flexible extension 145mmL

Spinner

Universal joint

Magnetic socket pick-up

3/8"DR. Part

- 6pt. Flank socket
6; 7; 8; 9; 10; 11; 12; 13; 14; 15;
16; 17; 18; 19; 20; 21; 22; 23; 24 mm
- 6pt. Flank deep socket (63mmL)
8; 9; 10; 12; 13; 14 mm
30 teeth ratchet handle
Flexible ratchet handle
Extension 3" & 6"
Wobble extension 44mm
Universal joint
Adaptor for Extension 1/2"(F)x3/8"(M)
- Spark plug socket 14; 16; 18; 20.6 mm
- Spline socket bit M5; M6; M8; M9; M10; M12

1/2" Part

- 6pt. Flank socket
10; 11; 12; 13; 14; 15; 16; 17; 18; 19; 21; 22; 24; 27; 30; 32 mm
- 6pt. Flank deep socket
14; 15; 17; 19; 22; 24 mm
- ⊕ Star socket
E12; E14; E16; E18; E20; E22; E24
36 teeth ratchet handle
Extension 5" & 10"
Universal joint
Adaptor for ext. 3/8"(F)x1/2"(M)
- Others:
- ⊕ Hex ball point long key set
1.27; 1.5; 2; 2.5; 3; 4; 5; 6; 8; 10mm

3



No.5505

50pc Wrench set

- Double open end wrench
6x7; 8x9; 10x11; 12x13; 14x15; 16x17; 18x19;
20x22; 21x23; 24x27; 25x28; 30x32 mm
- Combination wrench
6; 7; 8; 9; 10; 11; 12; 13; 14; 15; 16; 17; 18; 19;
20; 21; 22; 23; 24; 25; 26; 27; 28; 29; 30; 32 mm
- 75° offset ring wrench
6x7; 8x9; 10x11; 12x13; 14x15; 16x17; 18x19;
20x22; 21x23; 24x27; 25x28; 30x32 mm

4

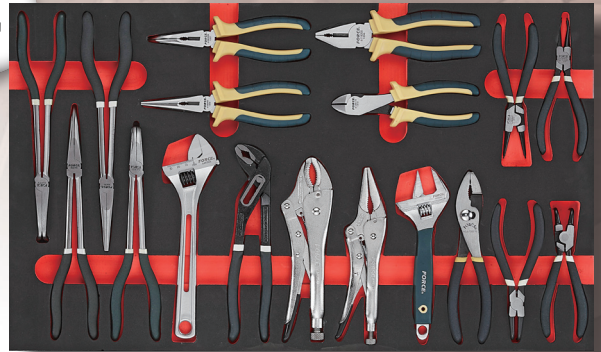

No.5188

18pc Pliers set

- Adjustable wrench 10"
- Adjustable wrench 8", jaw opening 38mm
- Waterpump pliers 10"
- Locking pliers 10"
- Long nose locking pliers 9"
- Long nose straight pliers 11"
- Long nose 45 de. pliers 11"
- Long nose 90 de. pliers 11"
- Multi-purpose 4 points gripping pliers 11"
- Long Nose pliers 8"
- Bent long Nose pliers 8"
- Combination pliers 8"
- Diagonal pliers 7"
- Slip joint pliers 8.5"
- Snap ring pliers
- External straight tip 1.8mm (open)
- Internal straight tip 1.8mm (close)
- External 90° bent tip 1.8mm (open)
- Internal 90° bent tip 1.8mm (close)

5



No.5352

35pc Utility set

- Utility Knife (incl. 2pc blades)
- 8" Flat file
- 8" Half round file
- 8" Round file
- 8" Square file
- 8" Triangular file
- Stainless steel vernier caliper
- Auto center punch
- Stainless steel straight rule 30cm
- Stainless steel protractor
- Screw pitch gauges 0.25-6 (Metric)
- Screw pitch gauges 4-62 (SAE)
- Steel scriber
- 5m measuring tape
- 26 sizes Feeler gauges (SAE & Metric)
- Hacksaw 315mml
- Aviation tin snips - straight cut
- Wire brush
- Chisel 12mm (150mml)
- Ribbed chisel 21mm (150mml); 26mm (200mml)
- Cape chisel (150mml)
- Pin punch 2mm (140mml); 3mm (150mml); 4mm (190mml)
5mm (200mml); 6mm (210mml); 8mm (215mml)
- Tape punch 3mm (185mml)
- Center pinch 4 (185mml)
- Engineer hammer 300gw
- Rubber hammer 400gw
- 3-in-1 Magnetic flexible pickup tool
- Technician's scissors 145mml
- Scriber of wolfram steel

1

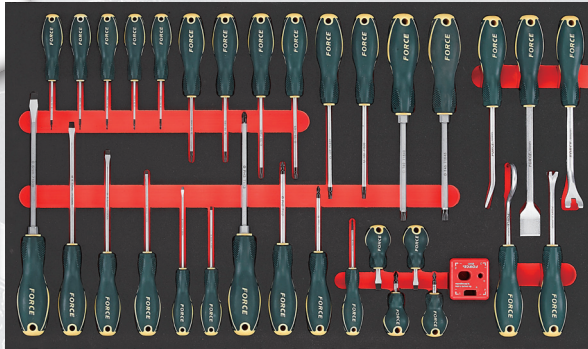

No.2335

33pc Screwdriver and Auto body tool set

- ⊕ Phillips screwdriver
PH.0x60mmL; PH.1x80mmL; PH.2x100mmL; PH.3x150mmL
- ⊕ Stubby Phillips screwdriver
PH.1x25mmL; PH.2x25mmL
- Slotted screwdriver
3mmx75mmL; 3.5mmx100mmL; 4mmx100mmL;
5.5mmx125mmL; 6.5mmx150mmL; 8mmx175mmL
- Stubby slotted screwdriver
5.5mmx25mmL; 6.5mmx25mmL
- ⊕ Star screwdriver
T5; T6; T7; T8; T9; T10; T15; T20; T25; T27; T30; T40; T45
- Demagnetizer / Magnetizer
- Trim pad remover (big)
- Trim pad remover (small)
- Gasket scraper
- Radiator hose remover
- Cotter pin puller

2

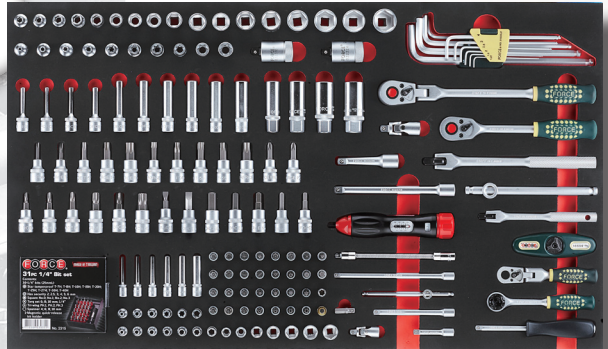

No.31871

187pc 1/4" & 3/8" DR. Socket combination set

Contents: 1/4" & 3/8" DR.

1/4" Part

- 6pt. Flank socket
3.2; 4; 4.5; 5; 5.5; 6; 7; 8; 9; 10; 11; 12; 13; 14 mm
- Star socket E4; E5; E6; E7; E8; E10
- Star deep socket (50mmL) E4; E5; E6; E7; E8; E10
- Socket bit (32mmL)
- ⊕ Phillips PH.0; PH.1; PH.2; PH.3
- ⊕ Pozidriv PZ.0; PZ.1; PZ.2; PZ.3
- Slotted 3; 4; 5.5; 6.5 mm
- Hex 3; 4; 5; 6 mm
- ⊕ Star T8; T10; T15; T20; T25; T27; T30
- ⊕ Star tamperproof T-8H; T-10H; T-15H; T-20H; T-25H; T-27H; T-30H
- Ratchet handle (72 teeth)
- Flexible bit ratchet handle
- Swivel handle
- T mini ratchet
- Extension 2" & 4" & 6"
- Sliding T handle
- Universal joint
- Magnetic socket pick-up
- Spinner
- Flexible inhex extension
- 1/4" Magnetic bit holder
- 1/4" Hex-1/4" Sq. bit adaptor
- Torque driver 1.5~8Nm

Bits set

- ⊗ 1/4" Torq set bit 25mmL 6; 8; 10; 1/4"
- ⊕ 1/4" Tri-wing bit 25mmL PH.1; PH.2; PH.3
- ⊕ 1/4" Spanner bit 25mmL 4; 6; 8; 10
- ⊕ 1/4" Hex security bit 25mmL 2; 2.5; 3; 4; 5; 6mm
- ⊕ 1/4" Star tamperproof bit 25mmL T-7H; T-8H; T-10H; T-15H; T-20H; T-25H; T-27H; T-30H; T-40H
- ⊕ 1/4" Square bit 25mmL 0; 1; 2; 3
- Magnetic quick-release holder (81260Q)

3/8" Part

- 6pt. Flank socket (MM)
6; 7; 8; 9; 10; 11; 12; 13; 14; 15; 16; 17; 18; 19; 20; 21; 22 mm
- Star socket
E4; E5; E6; E7; E8; E10; E11; E12; E14; E16
- Star deep socket
E4; E5; E6; E7 (55mmL)
E8; E10; E11; E12; E14; E16 (63mmL)
- Socket bit 3/8" (50 mml)
- ⊕ Phillips PH.4
- ⊕ Pozidriv PZ.4
- Slotted 7; 8 mm
- Hex 7; 8; 9; 10; 12 mm
- ⊕ Star T40; T45; T50; T55; T60
- ⊕ Star tamperproof T-40H; T-45H; T-50H; T-55H; T-60H
- Spline M5; M6; M8; M9; M10; M12
- Ratchet handle
- Flexible ratchet handle
- Swivel handle
- Extension 3" & 6"
- Universal joint
- Sliding T bar
- Spark plug socket 14; 16; 18; 20.6 mm
- Torque adapter 18Nm; 24Nm

Others:

- ⊗ Hex ball point extra long key set
1.27; 1.5; 2; 2.5; 3; 4; 5; 6; 8; 10 mm

3

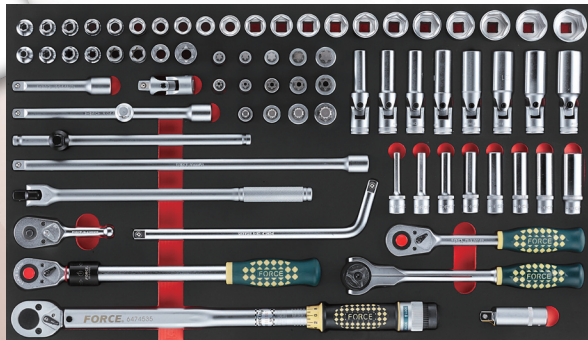

No.4732

74pc 1/2" DR. Socket combination set

- 6pt. Flank socket
8; 10; 11; 12; 13; 14; 15; 16; 17; 18; 19;
20; 21; 22; 23; 24; 26; 27; 28; 30; 32 mm
- 1/2" Universal socket 13; 14; 15; 17; 19; 21; 22; 24 mm
- Star socket E8; E10; E12; E14; E16; E18; E20; E24
- Star deep socket E8; E10; E12; E14; E16; E18; E20; E24
- Star socket bit (55mmL) T45; T50; T55; T60; T70
- ⊕ Star tamperproof socket bit (55mmL)
T-45H; T-50H; T-55H; T-60H; T-70H
- Spline socket bit (55mmL) M10; M12; M14; M16
- Lock Torque wrench
- Swivel handle 15"
- Stubby ratchet handle 45 teeth
- 72 teeth flexible round ratchet handle
- Ratchet handle
- 105°L handle 315mmL
- Adjustable handle (turn-lock design)
- Sliding T bar
- Extension 5" & 10" & 18"
- Universal joint
- Adaptor for ext. 3/8"(F)x1/2"(M)
- 1/2" DR. Extension with light
- 1/2" Ratchet handle-36 teeth

4



No.5505

50pc Wrench set

Double open end wrench
6x7; 8x9; 10x11; 12x13; 14x15; 16x17; 18x19;
20x22; 21x23; 24x27; 25x28; 30x32 mm
Combination wrench
6; 7; 8; 9; 10; 11; 12; 13; 14; 15; 16; 17; 18; 19;
20; 21; 22; 23; 24; 25; 26; 27; 28; 29; 30; 32 mm
75° offset ring wrench
6x7; 8x9; 10x11; 12x13; 14x15; 16x17; 18x19;
20x22; 21x23; 24x27; 25x28; 30x32 mm

5

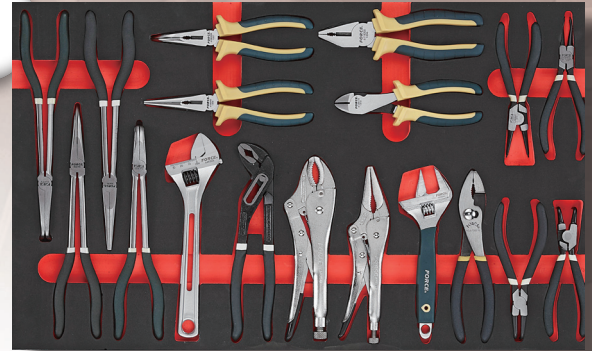

No.5188

18pc Pliers set

Adjustable wrench 10"
Adjustable wrench 8", jaw opening 38mm
Waterpump pliers 10" Locking pliers 10"
Long nose locking pliers 9" Long nose straight pliers 11"
Long nose 45 de. pliers 11" Long nose 90 de. pliers 11"
Long Nose pliers 8" Bent long Nose pliers 8"
Combination pliers 8" Diagonal pliers 7"
Slip joint pliers 8.5"
Multi-purpose 4 points gripping pliers 11"
External straight tip 1.8mm (open)
Internal straight tip 1.8mm (close)
External 90° bent tip 1.8mm (open)
Internal 90° bent tip 1.8mm (close)

6



No.5352

35pc Utility set

Utility Knife (incl. 2pc blades)
8" Flat file 8" Half round file
8" Round file 8" Square file
8" Triangular file
Stainless steel vernier caliper
Auto center punch
Stainless steel straight rule 30cm
Stainless steel protractor
Screw pitch gauges 0.25-6 (Metric)
Screw pitch gauges 4-62 (SAE)
Steel scribe
5m measuring tape
26 sizes Feeler gauges (SAE & Metric)
Hacksaw 315mmL
Aviation tin snips - straight cut
Wire brush
Chisel 12mm (150mml)
Ribbed chisel 21mm (150mml); 26mm (200mml)
Cape chisel (150mml)
Pin punch 2mm (140mml); 3mm (150mml); 4mm (190mml)
5mm (200mml); 6mm (210mml); 8mm (215mml)
Tape punch 3mm (185mml)
Center pinch 4 (185mml)
Engineer hammer 300gw
Rubber hammer 400gw
3-in-1 Magnetic flexible pickup tool
Technician's scissors 145mml
Scriber of wolfram steel

7



No.4812

81pc 1/2" DR. Impact socket combination set

● 6pt. Flank impact socket
8;10; 11; 12; 13; 14; 15; 16; 17; 18; 19;
21; 22; 23; 24; 27; 30; 32; 33; 34; 35; 36 mm
● 6pt. Flank impact deep socket
8; 10; 11; 12; 13; 14; 15; 16; 17; 18; 19; 21;
22; 23; 24; 27; 30; 32; 33; 34; 35; 36 mm
○ Impact hex socket bit (one-piece)
4; 5; 6; 7; 8; 10; 12; 14; 17; 19 mm (60mml)
○ Impact star socket bit (one-piece)
T20; T25; T27; T30; T40; T45; T50; T55; T60; T70 (60mml)
○ Impact spline socket bit (one-piece)
M8; M10; M12 (60mml)
M12; M14; M16; M18 (78mml)
Super duty reactionless impact ratchet wrench
(Max Torque: 89ft-lb / 120 N.m)
Impact wrench (Max Torque: 780ft-lb / 1054 N.m)
Impact extension 3"; 5"; 10"
Universal joint (ball type)
Adaptor (ball type) 1/2"(F)x3/8"(M); 1/2"(F)x3/4"(M)
Bit holder 1/2"(F)x1/4"hex(F); 1/2"(F)x1/4"hex(F)

■ 10318-477

■ 10318B-477

■ 10318R-477

1

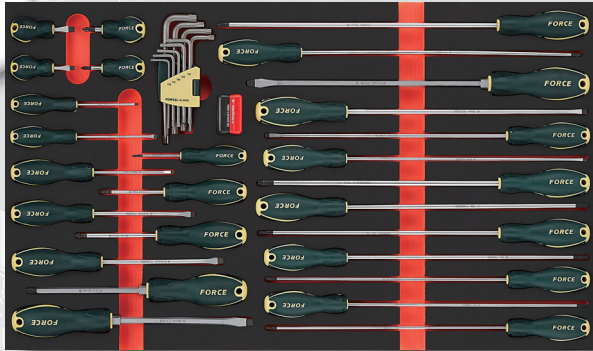

No.2371

37pc Screwdriver set

- Adjustment screwdriver
- ⊕ Phillips screwdriver PH.1; PH.2
- Slotted screwdriver 4; 5; 6; 8mm
- ⊕ Star screwdriver
- T10; T15; T20; T25; T27; T30; T40 (300mm)
- ⊕ Phillips screwdriver PH.0; PH.1; PH.2; PH.3
- ⊕ Phillips stubby screwdriver PH.1; PH.2
- Slotted screwdriver 3; 3.5; 4; 5.5; 6.5; 8
- Slotted stubby screwdriver 5.5; 6.5
- ⊕ Star long key set
- T10; T15; T20; T25; T27; T30; T40; T45; T50
- Demagnetizer / Magnetizer

1/2" Part

- 6pt. Flank socket 10; 11; 12; 13; 14; 15; 16; 17; 18; 19; 21; 22; 24; 27; 30; 32 mm
- 6pt. Flank deep socket 14; 15; 17; 19; 22; 24 mm
- ⊕ Star socket E12; E14; E16; E18; E20; E22; E24
- 36 teeth ratchet handle
- Extension 5" & 10"
- Universal joint
- Adaptor for ext. 3/8"(F)x1/2"(M)
- Others:
- ⊕ Hex ball point long key set
- 1.27; 1.5; 2; 2.5; 3; 4; 5; 6; 8; 10mm

2

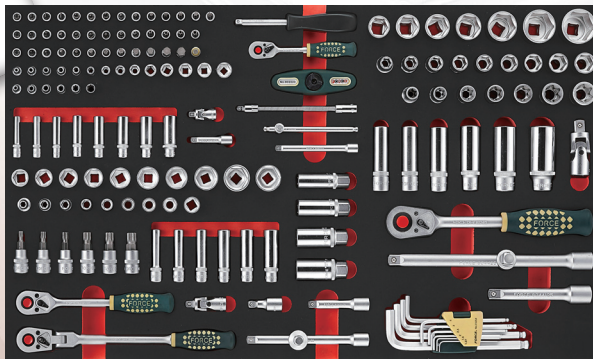

No.41621

162pc 1/4", 3/8" & 1/2" DR. Socket combination set

- Contents: 1/4" & 3/8" & 1/2"DR.
- 1/4" Part
- 6pt. Flank socket 3.2; 4; 4.5; 5; 5.5; 6; 7; 8; 9; 10; 11; 12; 13; 14 mm
 - 6pt. Flank deep socket (50mmL) 6; 7; 8; 9; 10; 11; 12; 13 mm
 - ⊕ Star socket E4; E5; E6; E7; E8; E10
- Socket bit (32mmL)
- ⊕ Phillips PH.0; PH.1; PH.2; PH.3
 - Slotted 3; 4; 5.5; 6.5 mm
 - ⊕ Pozidriv PZ.0; PZ.1; PZ.2; PZ.3
 - Hex 3; 4; 5; 6; 7; 8; 9; 10 mm
 - ⊕ Star T8; T9; T10; T15; T20; T25; T27; T30; T35; T40
 - ⊕ Star tamperproof T-8H; T-10H; T-15H; T-20H; T-25H; T-27H; T-30H; T-35H; T-40H
- | | |
|--------------------------------|---------------------------|
| 20 teeth ratchet handle | Flexible extension 145mmL |
| 48 teeth T mini ratchet handle | Spinner |
| Sliding T handle | Universal joint |
| Extension 2" & 4" | Magnetic socket pick-up |
- 3/8"DR. Part
- 6pt. Flank socket 6; 7; 8; 9; 10; 11; 12; 13; 14; 15; 16; 17; 18; 19; 20; 21; 22; 23; 24 mm
 - 6pt. Flank deep socket (63mmL) 8; 9; 10; 12; 13; 14 mm
 - 30 teeth ratchet handle
 - Flexible ratchet handle
 - Extension 3" & 6"
 - Wobble extension 44mm
 - Universal joint
 - Adaptor for Extension 1/2"(F)x3/8"(M)
 - Spark plug socket 14; 16; 18; 20.6 mm
 - Spline socket bit M5; M6; M8; M9; M10; M12

3

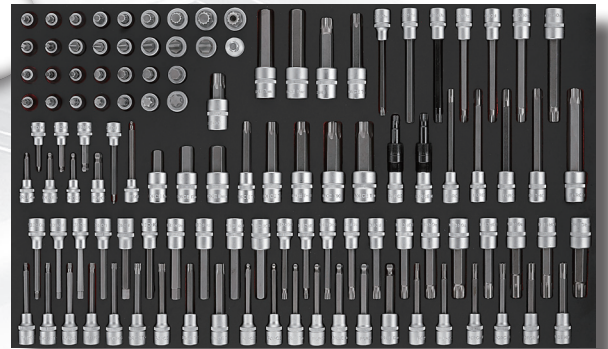

No.41141

114pc 1/2" DR. Socket bit set

- Contents: 3/8" & 1/2"DR.
- 3/8" Part
- ⊕ 3/8" Hex ball point socket bit 3; 4; 5; 6; 7; 8; 10 (62mmL)
 - 3; 4 (100mmL)
- 1/2" Part
- ⊕ Star socket bit (55mmL) T40; T45; T47; T50; T55; T60; T70
 - ⊕ Star socket bit (70mmL) T80
 - ⊕ Star socket bit (100mmL) T20; T25; T27; T30; T40; T45; T50; T55; T60; T70; T80; T90; T100
 - ⊕ Star socket bit (140mmL) T60
 - ⊕ Star tamperproof socket bit (100mmL) T-55H
 - ⊕ Star tamperproof socket bit (105mmL) T-70H
 - ⊕ Star tamperproof socket bit (130mmL) T-30H
 - ⊕ Star tamperproof socket bit (140mmL) T-80H
 - ⊕ Phillips PH.4
 - ⊕ Pozidriv PZ.4
 - Slotted 9; 10; 11; 12; 14; 16 mm
 - Hex 5; 6; 7; 8; 9; 10; 12 mm (55mmL)
 - Hex 14 mm (65mmL)
 - Hex 17; 19 mm (70mmL)
 - Hex 5; 6; 7; 8; 9; 10; 11; 12; 13; 14 mm (100mmL)
 - Hex 17; 19 mm (110mmL)
 - Hex 10 mm (140mmL)
 - ⊕ Hex ball point 5; 6; 7; 8; 9; 10; 12 mm(100mmL)
 - Spline M5; M6; M8; M9; M10; M12; M14; M16 (55mmL)
 - Spline security M16 (55mmL)
 - Spline M5; M6; M8; M9; M10; M12; M14; M16 (100mmL)
 - Spline security M16 (100mmL)
 - Spline M9; M10; M12; M14 (140mmL)
 - ⊕ Ribe M5; M6; M7; M8; M9; M10; M12; M13; M14; M16 (100mmL)
 - ⊕ Ribe M8; M9; M12 (140mmL)
 - ⊕ Ribe M10 (140mmL)
- M10 Alternator tools
- 1/2"DR. Spline (XZN) socket bit M10x110mmL
 - Reaction corkscrew cap 33 teeth-Ø19mm-17mm hex
- T50 Alternator tools
- ⊕ 1/2"DR. Star socket bit T50x110mmL
 - Reaction corkscrew cap 33 teeth-Ø19mm-17mm hex
 - Adaptor 1/2"(F) - 3/8"(M)

4



No.5505

50pc Wrench set

Double open end wrench
6x7; 8x9; 10x11; 12x13; 14x15; 16x17; 18x19;
20x22; 21x23; 24x27; 25x28; 30x32 mm
Combination wrench
6; 7; 8; 9; 10; 11; 12; 13; 14; 15; 16; 17; 18; 19;
20; 21; 22; 23; 24; 25; 26; 27; 28; 29; 30; 32 mm
75° offset ring wrench
6x7; 8x9; 10x11; 12x13; 14x15; 16x17; 18x19;
20x22; 21x23; 24x27; 25x28; 30x32 mm

5

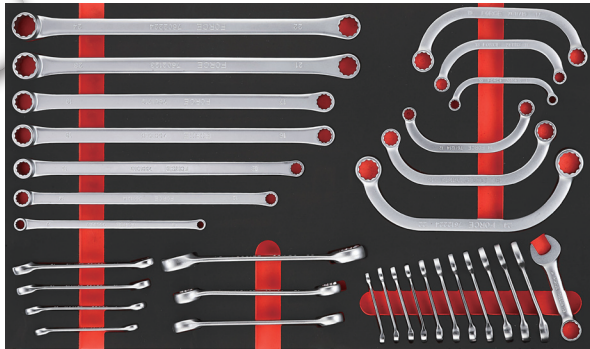

No.5321

32pc Spanner set

Flare nut wrench 8x10; 9x11; 12x13; 14x15; 16x18; 17x19; 22x24 mm
Extra long flat ring wrench
8x10; 12x14; 13x15; 16x18; 17x19; 21x23; 22x24 mm
Half-moon ring wrench 8x10; 11x13; 12x14; 16x18; 17x19; 22x24 mm
Midget combination wrench 8; 9; 10; 11; 12; 13; 14; 15; 16; 17; 18; 19 mm

6



No.5286

28pc Pliers and hammer chisel set

Multi-purpose 4 points gripping pliers 11"
Chisel 12(150mmL); 15(180mmL); 19(200mmL); 25(220mmL)
Pin punch 2(140mmL); 3(150mmL); 4(190mmL); 5(200mmL); 6(210mmL)
Center punch 2.5mm (185mmL); 4mm (185mmL); 6mm (185mmL)
Adjustable gauged wrench 250mmL
Snap ring pliers (bent-close) 180mm
Snap ring pliers (bent-open) 180mm
Snap ring pliers (straight-close) 180mm
Snap ring pliers (straight-open) 180mm
Heavy duty stripper pliers
Long Nose pliers 8"
Combination pliers 7"
Technician's scissors
Engineer hammer 300gw
Diagonal pliers 7"
Waterpump pliers 10"
Locking pliers 10"
Electrician folding knife
Rubber hammer 520gw

7

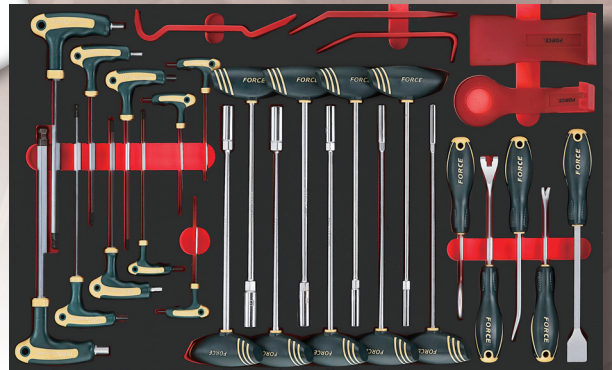

No.5292

29pc Hex grip key, nut driver & auto body tool set

- ⊗ Hex & Hex ball point grip key (Dual material)
2; 2.5; 3; 4; 5; 6; 7; 8; 10; 12mm
- Hex nut driver T handle
6; 7; 8; 9; 10; 11; 12; 13; 14mm
- 5pc Handy remover set
Trim pad remover (big)
Trim pad remover (small)
Gasket scraper
Radiator hose remover
Cotter pin puller

8



No.4791

79pc Impact socket & torque wrench set

- Impact hex socket bit (one piece)
4; 5; 6; 7; 8; 10; 12; 14; 17; 19 mm (60mmL)
- ⊗ Impact star socket bit (one piece)
T20; T25; T27; T30; T40; T45; T50; T55; T60; T70 (60mmL)
- Impact spline socket bit (one piece)
M8; M10; M12 (60mmL)
M12; 14; M16; M18 (78mmL)
- ⊗ 6pt. Flank impact socket
8; 10; 11; 12; 13; 14; 15; 16; 17; 18;
19; 21; 22; 23; 24; 27; 30; 32; 36 mm
- ⊗ 6pt. Impact deep socket
8; 10; 11; 12; 13; 14; 15; 16; 17; 18;
19; 21; 22; 23; 24; 27; 30; 32; 36mm
- ⊗ 6pt. Flank impact socket (colored) 17; 19; 21mm
- ⊗ 6pt. Flank impact thin-wall deep socket 17; 19; 21mm
- Impact extension (ball) 75; 125mmL
- 1/2" Universal joint (ball type)
- Impact adaptor 3/8"(F)x1/2"(M) (ball)
- Impact adaptor 3/4"(F)x1/2"(M) (ball)
- 1/2"DR. Bit holder
- 1/2"(F)x1/4"Hex(F); 1/2"(F)x5/16"Hex(F)
- 1/2" Lock torques wrench

■ 10318-531

■ 10318B-531

■ 10318R-531

For trolley 10318 series

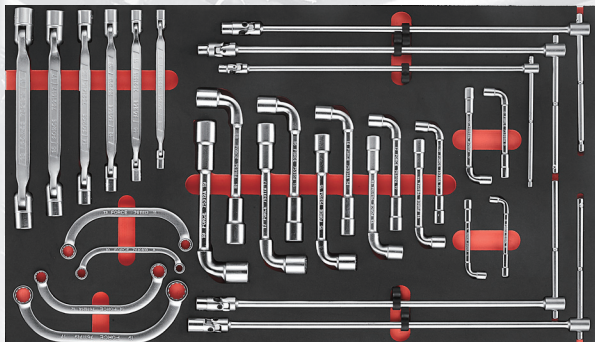

NO.5293

29pc Wrench set

- Angle wrench 12pt.-6pt.
6; 7; 8; 9; 10; 11; 12; 13; 14; 15; 16; 17; 18; 19 mm
- Hinged socket wrench
8x9; 10x11; 12x13; 14x15; 16x17; 18x19 mm
- Half-moon ring wrench
8x10; 11x13; 12x14; 17x19mm
- Universal long nut driver
8; 10; 12; 13; 14 mm

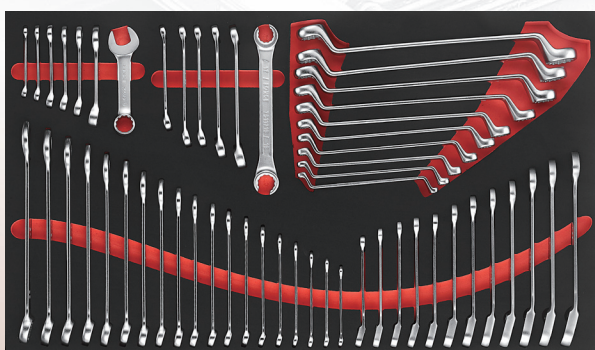

NO.5542

54pc Wrench set

- Combination wrench
6; 7; 8; 9; 10; 11; 12; 13; 14; 15; 16; 17; 18; 19; 20; 21; 22;
23; 24 mm
- 75° Offset ring wrench
6x7; 8x9; 10x11; 12x13; 14x15; 16x17; 18x19; 20x22;
21x23; 24x27 mm
- Flare nut wrench
8x10; 9x11; 10x12; 11x13; 12x14; 17x19 mm
- Reversible gear wrench
8; 9; 10; 11; 12; 13; 14; 15; 16; 17; 18; 19 mm
- Midget combination wrench
8; 10; 12; 13; 14; 17; 19 mm



Part No.	Page	Part No.	Page	Part No.	Page	Part No.	Page	Part No.	Page
1013-550	12	10217R-233	7	10318B-298	44	4562	18	5212	40
1013A-550	12	10217R-270	6	10318B-477	47	4573	41	5223	30
1013B-550	12	10218-193	4	10318B-531	49	4613	18	5232	40
1013R-550	12	10218-198	5	10318R-298	44	4615	42	5263	30
102101	3	10218-233	7	10318R-477	47	4655	19	5271	30
102101B	3	10218-246	9	10318R-531	49	4656	19	5283	31
102101R	3	10218-270	6	21261	16	4661	19	5286	49
102102	3	10218-370	8	2182	43	4662	20	5291	31
102102B	3	10218-405	11	2195	28	4685	20	5292	49
102102R	3	10218-415	10	2196	28	4701	20	5293	50
102103P	2	10218A-193	4	2208	14	4732	46	5302	31
102104	3	10218A-198	5	2212	28	4751	21	5311	32
102104B	3	10218A-233	7	2262	14	4791	49	5312	32
102104R	3	10218A-246	9	2335	44	4811	27	5321	49
102105	3	10218A-270	6	2335	46	4812	47	5322	32
102105B	3	10218A-370	8	2363	14	4881	21	5332	33
102105R	3	10218A-405	11	2371	48	4882	22	5352	45
102106	2	10218A-415	10	2412	15	4883	22	5352	47
102106A	2	10218B-193	4	2415	15	5117	36	5353	33
102106B	2	10218B-198	5	2581	15	51217	36	5361	33
102106R	2	10218B-233	7	31331	17	51228	36	5362	34
102170BBS	3	10218B-246	9	31332	17	51311	36	5363	34
102170LK	2	10218B-270	6	31871	46	5147	37	5365	34
10217-193	4	10218B-370	8	3262	43	5155	37	5371	35
10217-198	5	10218B-405	11	3981	16	51610	37	5372	35
10217-233	7	10218B-415	10	41041	27	5168	29	5421	35
10217-270	6	10218R-193	4	41085	23	5169	38	5505	45
10217A-193	4	10218R-198	5	41121	23	5177	29	5505	47
10217A-198	5	10218R-233	7	41141	48	5178	37	5505	49
10217A-233	7	10218R-246	9	41161	24	5179	38	5542	50
10217A-270	6	10218R-270	6	41281	24	5186	38	56261	40
10217B-193	4	10218R-370	8	41371	25	5188	45	6215	25
10217B-198	5	10218R-405	11	41621	44	5188	47	6232	25
10217B-233	7	10218R-415	10	41621	48	5195	39	6321	42
10217B-270	6	10318-298	44	4341	41	5207	39	6421	26
10217R-193	4	10318-477	47	4483	18	5207A	39		
10217R-198	5	10318-531	49	4531	41	5208	29		



FORCE®

Shyang Yun Tools Co., Ltd.
Shyang Yun Hardware Co., Ltd.

No.161, Sitou Rd., Shengang Dist., Taichung City 42953, Taiwan

Tel: +886-4-25631268 Fax: +886-4-25632678

<http://www.force.com.tw> E-mail: info@force.com.tw

