

# FORCE®

## 2023 Addition

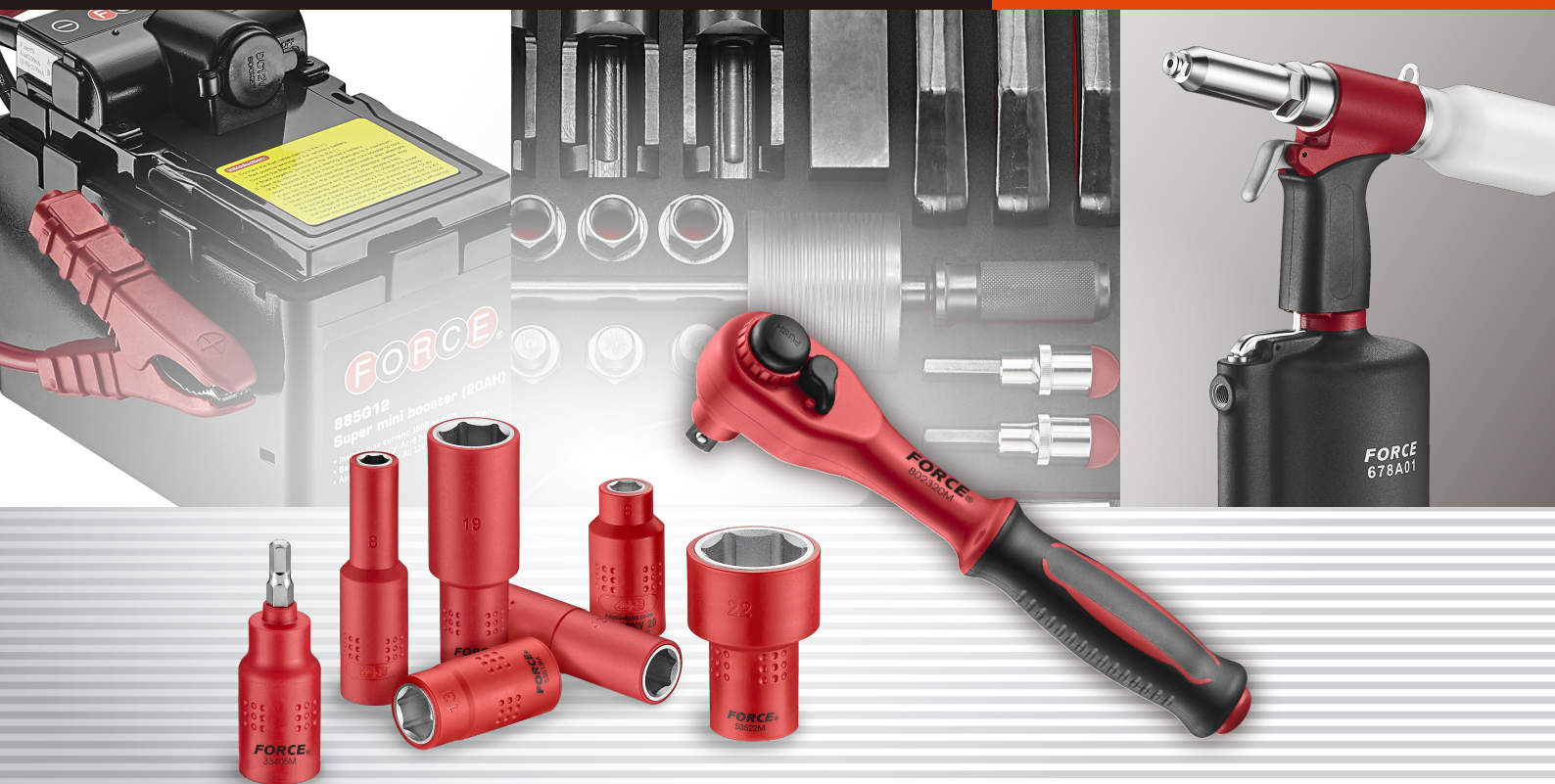

*Power you on*



## CERTIFICATE

Management system as per  
**ISO 9001: 2015**

In accordance with TÜV NORD CERT and TÜV AP Taiwan procedures, it is hereby certified that

**SHYANG YUN TOOLS CO., LTD.**  
No. 161, Sitou Rd., Shengang District,  
Taichung City 42953, Taiwan, Republic of China



applies a management system in line with the above standard for the following scope

**Design, Development and Manufacturing of Hand Tools, Auto Tools and  
Pneumatic Tools**

Certificate Registration No. 44 100 072011  
Audit Report No. TW-1760/2021

Valid from 2022-01-08  
Valid until 2025-01-07  
Issue Date 2021-12-17  
Initial Certification 2007-01-15



Certification Body  
at TÜV ASIA PACIFIC LIMITED Taiwan Branch

TÜV ASIA PACIFIC LIMITED  
Taiwan Branch  
Room A1, 9F, No.333, Sec.2,  
Tun Hua S. Rd.,  
Taipei 10668 Taiwan, R.O.C.

This certification was conducted in accordance with the TÜV ASIA PACIFIC LIMITED Taiwan Branch auditing and certification procedures based on TÜV NORD CERT auditing and certification procedures and is subject to regular surveillance audits.

[www.tuvnord.com.tw](http://www.tuvnord.com.tw)



Management System  
Certifications  
MS814

RDC, TW1760, RC

## General Information

This catalogue replaces all previous editions. All rights reserved in all countries. Reprinting and excerpts require a prior permission in writing by Shyang Yun Tools Co., Ltd.

The photographs and the technical details are of the articles at present offered.

Since we are constantly updating and improving our products to meet user needs and technological developments, we reserve the right to make modifications and changes with regard to photographs, specifications, sizes, packing, weights and performance without notice.

There is no liability for printing errors and correction or replacement supplies with regard to products already delivered.

Cancellations of all models and sets may be made at any time without there being any grounds for legal claim.

FORCE is a registered trademark.

All other trademarks mentioned in this document or website are the property of their respective owners.

The use of the word partner does not imply a partnership relationship between Shyang Yun Tools Co., Ltd. and any other company.

© Copyright by Shyang Yun Tools Co., Ltd.

All rights reserved.

# CONTENTS SUMMARY

*Anything you need for tools....*

P.1-1 ... P.1-30



**ENGINE**



P.2-31 ... P.2-40



**ELECTRICAL / CABLE**



P.3-41 ... P.3-56



**BRAKE / TRANSMISSION**



P.4-57 ... P.4-60



**TRUCK**



P.5-61 ... P.5-64



**AUTO BODY**



P.6-65 ... P.6-66



**MOTORCYCLE**



P.7-67 ... P.7-72



**PULLER / TORQUE WRENCH**



P.8-73 ... P.8-96



**GENERAL**





**4pc 3/8"DR. Magnetic spark plug socket (thin wall)**



**3041**

60/21.3/22.3/0.5'

356g

4pc 14; 16; 18; 20.6 mm (70mmL)

**Engine timing tool set for FORD 1.6 Ecoboost**



**907G21**

8/13.5/14.5/0.86'

1690g

- Specially-designed for aligning the engine timing for Ford 1.6 Ti-VCT, 1.5/1.6VVT Ecoboost engine.

- Application:

Ford: 2012-2017 B-Max	2013-2015 Kuga
2003-2017 C-Max	2007-2015 Mondeo
2008-2017 Fiesta	2010-2015 S-Max
2004-2017 Focus	2013-2015 Tourneo Connect
2010-2015 Galaxy	2013-2016 Transit Connect
2010-2017 Grand C-Max	
2013-2015 Grand Tourneo Connect	
Volvo: 2011-2015 S60	2011-2015 V60
2010-2015 S80	2010-2015 V70
2010-2015 V40	

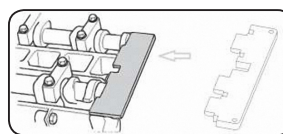
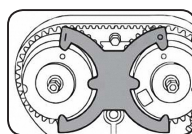

**Engine timing tool set for BMW N47, N47S**



**902G28**

4/13/13.6/0.9'

3250g

- Used to align the balance shaft and crankshaft timing position.
- Application: BMW N47/N47S (07-14) diesel engines in:
  - 1 Series: 118d, 120d, 123d, 125d (E81/E82/E87/E88/F20/F21)
  - 3 Series: 318d, 320d (E90/E91/E92/E93/F30/F31/F4)
  - 5 Series: 520d (E60/E61/F07/F10/F11)
  - X Series: X3 1.8d, 2.0d (E83)

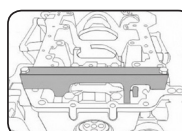
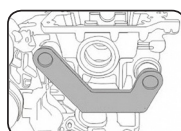

## Balance shaft & oil pump alignment kit for BMW N20, N26



**905G23**

10/5.5/6/0.43'

550g

- Developed to align the balance shafts into the correct timed position and also to lock the drive sprocket for removal and replacement of the oil pump and balance shaft housing.
- Application:  
BMW N20 (11-17), N26 (12-16) petrol engines in:  
1 Series: 125i (F20/21)  
2 Series: 220i, 228i (F22)  
3 Series: 320i, 328i (F30/31)  
4 Series: 420i (F32/33)  
5 Series: 520i, 528i (F10/11)  
X Series: X1 2.0i, 2.8i (E84), X3 2.0i (F25), X4 4.0i (F26)  
Z Series: Z4 2.0i, 2.8i (E89)

## Engine timing tool set for BMW S54



**907G20**

6/12.5/13.5/1.4'

2100g

- For checking and setting camshaft timing when installing VANOS adjustment unit on S54 engines.
- Application:  
BMW S54 (00-06) petrol engines in:  
3 Series: M3 (E46)  
Z Series: Z3 (E36), Z4 (E85/E86)



## Camshaft alignment tool for BMW S63

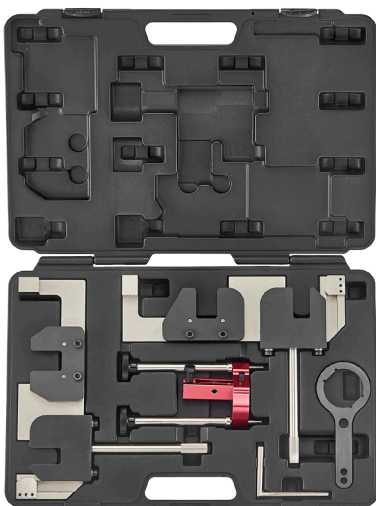

**905G28**

3/19.5/20.5/1'

6070g

- Special design to locate the camshaft in TDC position.
- Checking and adjusting the timing chain tensioner.
- Applicable:  
BMW S63 engine on F10/M5 (10~), F06/M6 (11~),  
F12 13/M6 (11~), E70/X5M (08~13), E71/X6M (08~13)



**Engine timing tool set for BMW S65**

**912G15**

5/14.2/14.8/1.4'

3336g

- Used to locate the camshaft in TDC position and correct the VANOS angle.
- Application:  
BMW S65 (07-13) petrol engines in:  
3 Series: M3 (E90/E92/E93)



**Engine timing tool set for BMW B38, B46, B48**

**911G10**

3/22/22.6/1.93'

6930g

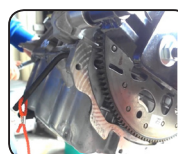
- Installation and removal of camshaft/ variable camshaft timing unit.
- Check and adjustment of timing.
- Application:  
BMW B38 (13-present), B46/B48 (14-present) petrol engines in:  
1 Series: 116i, 118i, 120i, 125i, 128ti (F20/F21/F40)  
2 Series: 218i, 220i, 220i, 225i, 228i, 230i  
(F22/F23/F44/F45/F46)  
3 Series: 318i, 320i, 330i (F30/F31/F34/G20)  
4 Series: 420i, 430i (F32/F33/F36/G22)  
5 Series: 520i, 530i (G30)  
X Series: X1 1.8i, 2.0i, 2.5i, 2.8i (F48),  
X2 1.8i, 2.0i, 2.5i, 2.8i (F39),  
X3 3.0i (G01),  
X4 3.0i (G02)



## Vacuum pump sealing cover remover and installer set for BMW N53, N54, N55



ENGINE



**911G11**



3/17.2/18.2/1.5'



5820g

- For removal and installation of sealing cap of vacuum pump.

- Application:

BMW N53 (06-13), N54 (06-16), N55 (09-present) petrol engines in:

1 Series: 125i, 128i, 130i, 135i (E81/E82/E87/E88)

3 Series: 320si, 323i, 325i, 328i, 330i, 335i  
(E90/E91/E92/E93/F30)

5 Series: 523i, 525i, 528i, 530i, 535i, 535GT  
(E60/E61/F07/F10/F11)

6 Series: 630i, 640i (E63/E64/F06/F12/F13)

7 Series: 730i, 730Li, 740i, 740Li (E65/E66/F01)

X Series: X3 2.5i/3.0i, X5 3.0i (E83/E70)

Z Series: Z4 2.5i/3.0i (E85/E86)

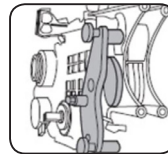
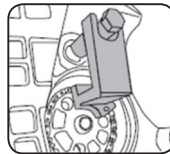

## Engine timing tool set for BENZ M133, M270, M274



347100100B

**916G7**



3/21.9/22.9/1.2'



7293g

- Special design for positioning the camshaft in TDC position.

- Application:

BENZ: M133 (13-19), M270 (11-19), M274 (11-19) petrol engines in:

A-Class: A160, A180, A200, A220, A250, A45 AMG (W176),  
CLA180, CLA200, CLA250, CLA45 AMG (C117),  
GLA180, GLA200, GLA250, GLA45 AMG (X156)

B-Class: B160, B180, B200, B250 (W246)

C-Class: C180 (W204),  
C180, C200, C250, C300 (W205)

E-Class: E180, E200, E250 (W212),  
E180, E200, E250, E300 (W213)

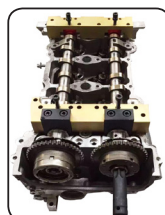



**Belt tensioner tool for BENZ**

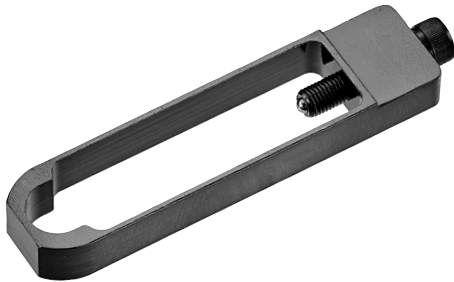

**9G0810**

30/10.8/11.8/0.66' 360g

- Effectively compresses hydraulic belt tensioner (alternator with start-stop function).
- Application:  
 BENZ: M266 (06-15) petrol engines in:  
 A-Class: A150, A160, A170, A180, A200, A200T (W169)  
 B-Class: B150, B160, B170, B180, B200, B200T (W245)

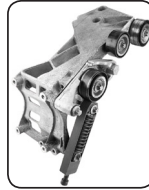

**Diesel engine timing chain tool kit for MERCEDES BENZ / CHRYSLER / JEEP**



**912G13**

10/24.8/25.0/0.9' 2304g

- The link separating tool and the link assembly tool allow for quick and easy separation and assembly of the timing chain.
- Suitable for duplex timing chains, for most Benz diesel engines.
- May also be used on some Chrysler / Jeep diesel engines.

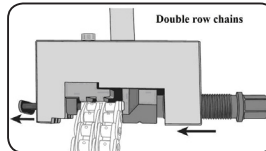

**Diesel engine timing chain tool kit for MERCEDES BENZ / CHRYSLER / JEEP**



**922G7**

4/11.6/11.9/0.6' 2932g

- The link separating tool and the link assembly tool allow for quick and easy separation and assembly of the timing chain.
- Suitable for simplex and duplex timing chains, for most Benz diesel/petrol engines.
- May also be used on some Chrysler / Jeep diesel engines.

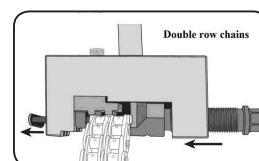
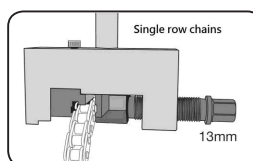





ENGINE



## Timing chain tensioning socket for VW / AUDI 4.0L



**9G0811**

 100/19.5/20.5/3.5'  195g



- For tensioning the timing chain with the camshaft adjuster.
- Used to rotate the cam phase when tightening the timing chain.
- Application:  
VAG 8-cylinder 4.0L TFSI direct injection engine in:  
Audi: A6 (11~), A7 Sportback (11~), A8 (10~)



## Timing chain tensioning socket for VW / AUDI 3.0L



**9G0812**

 100/20/21/3.5'  200g

- Used for tensioning timing chain via camshaft adjuster.
- Application:  
VAG 3.0L 6-Cylinder supercharged direct injection engine (generation IV) in:  
Audi: A6 (11~), A7 Sportback (11~), A8 (10~), Q5 (08~)  
Seat: Alhambra (11~)



## Engine timing tool set for VAG

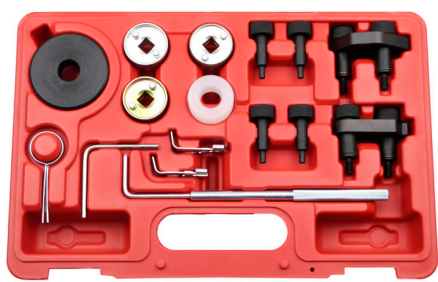

**916G8**

 10/15.6/16.6/1.8'  1560g

- Used for correct the camshaft and crankshaft timing position.
- Application:  
2006-2013 VAG series TSI, TFSI EA888 engine (1.8L, 2.0L)
- Engine code:  
BYT, BZB, CABA, CABB, CABD, CADA, CAEA, CAEB, CAWA, CAWB, CBFA, CCTA, CCZA, CCZB, CCZC, CDAA, CDAB, CDHA, CDHB, CDNB, CDNC, CDND, CESA, CETA, CFKA, CGYA, CJEB, CJBA, CJSB.

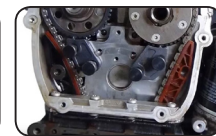
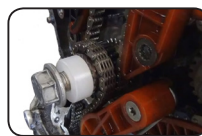



**Crankshaft seal remove / installing tool for VAG**



**9G0129A**

1737g

- Special-design tool to renew crankshaft sealing flange.
- Application:  
Audi: A3 (04-), A4 (04-)  
VW: Golf (04-), Touran (04-)  
1.4i Turbo, 1.4 & 1.6 petrol direct injection and  
1.9/2.0 SDI, 2.0 Common rail diesel engines (4 cylinder).



**Camshaft adapter socket for VAG**



**9G0618**

120/14.4/15.4/2'

120g

- Used to rotate and hold intake camshaft during timing chain service on 4-cylinder 1.8 and 2.0 liter 4V TFSI direct injection engine (generation III).
- Application:
 

Audi:	2012-2016 A3	2009-2011 A5
	2013-2016 A3 Cabriolet	2009-2012 A5 Cabriolet
	2012-2016 A3 Sportback	2009-2016 A5 Sportback
	2008-2015 A4	2015-2017 TT
	2012-2015 A4 Quattro	
Seat:	2011-2016 Alhambra	2009-2016 Exeo
	2009-2016 Altea	2009-2017 Leon
	2009-2016 Altea Freetrack	2013-2017 Leon ST
	2009-2016 Altea XL	
Skoda:	2008-2013 Octavia II	2008-2015 Superb II
	2013-2017 Octavia III	2015-2017 Superb III
	2013-2015 Yeti	
VW:	2013-2016 Beetle	2005-2011 Jetta V
	2012-2015 CC	2011-2016 Jetta VI
	2008-2015 EOS	2011-2017 Passat
	2014-2017 Golf Alltrack	2007-2015 Tiguan
	2003-2009 Golf V	2014-2017 Touran
	2009-2013 Golf VI	
	2012-2015 Golf VII	
- Engine codes:  
CDAA, CDAB, CDHA, CDHB, CJEB, CJEE, CJSA, CJSB, CJEB, CNCD, CNCE, CNDC, CDNB, CDNC, CFKA, CPSA

## Vibration damper holding tool set for VAG



**905G26**



6/10.3/11.3/1.4'



1722g

- Used for dismantling and assembling the vibration damper on the vehicles listed on 4 cyl. 1.8L, 2.0L, 4V TFSI direct injection engine.

- Engine codes:

BZB, BYT, CABA, CABB, CABD, CDHA, CDHB, CJED, CJEE, CJSA, CAWA, CAWB, CBFA, CCTA, CCZA, CCZC, CDA, CDNC, CDND, CCZB, CCZD, CDAB, CDNB, CESA, CETA, CFKA, CFPA, CGYA, CHHA, CHHB, CJK, CHHC, CHJA, CJKB, CJSB, CJSC, CJXA, CJXB, CJXC, CJXE, CJXG, CJXH, CNCB, CNCD, CNCE, CPLA, CPSA, CULA, CULB, CULC, CYNB, CYPA, CYRB, CYRC, CWZA, CYBB, CYGA, DAJA, DAJB, DEDA



- Application:

Audi:

2015-2017 A1

2007-2017 A3

2007-2017 A4

2007-2017 A5

2012-2017 A6

2014-2017 A7

2012-2014 A8

2011-2017 Q3

2008-2017 Q5

2008-2017 TT

2015-2017 Q7

2014-2017 S1

2013-2017 S3

Seat:

2006-2015 Altea

2010-2013 Exeo

2015-2017 Ibiza

2007-2017 Leon

2007-2017 Toledo

Skoda:

2007-2017 Octavia

2008-2017 Superb

VW:

2010-2016 Amarok

2013-2017 Beetle

2012-2015 CC

2008-2015 Eos

2007-2017 Golf

2008-2017 Scirocco

2011-2017 Sharan

2009-2015

Yeti

2007-2016

Tiguan

2015-2017

Touran

2011-2015

Transporter T5

2015-2017

Transporter T6

2007-2017

Passat

2014-2017

Polo

## Engine timing tool set for FIAT / ALFA ROMEO



**910G10**



10/10.8/11.8/1.4'



1080g

- Features a camshaft setting plate, crankshaft locking tool and tensioner adjuster.

- Application:

FIAT, ALFA ROMEO 1.4 Multiair petrol engines in:

Fiat: Bravo (10-15), Punto Evo (09-12), Punto (12-14)

Alfa Romeo: Guilietta (10-16), MiTo (09-16)

- Engine codes: 198A7.000, 940A2.000, 955A2.000, 955A6.000, 955A7.000, 955A8.000





**Crankshaft pulley holder for BMW N47, N57**



**905G25**



5/13.7/14.1/0.85'



2250g

- Used for aligning and holding the angle of the crankshaft and pulley while installing and removing the crankshaft pulley.
- Application:  
BMW N47/N47S (07-14), N57 (08-18) diesel engines in:  
1 Series: 118d (E81/E87)  
120d (E81/E82/E87)  
123d (E81/E82/E87)  
3 Series: 318d (E90/E91)  
320d (E90/E91/E92)  
5 Series: 520d (E60/E61)  
X Series: X2 2.0d (E83)

**Camshaft pulley holder for SUBARU**



**9G0619**



10/7.2/8.2/0.69'



724g

- The tool is designed to fix the timing belt, and to remove or install the camshaft pulley.
- Front part with 12 points/60mm could be used on the belt of 6 points and 12 points.
- Application:  
Subaru: Impreza EJ20 engine, Impreza WRX with 2.0 turbo 2002-2005 and some 2.5 L turbo engines requiring use of the both SU 3625 and SU 200T.

Note: This tool will not fit 2.0 turbo 2005 with the variable cam timing.



**Camshaft pulley holder for SUBARU**



**9G0620**



8/8.6/9.6/1.0'



1073g

- Size: 90 mm
- Used for fixing, removing, and installing timing belt easily.
- Front part with 3 points which could fix the belt of Forester.
- Suitable for Subaru Forester 2500 C.C



### 3 in 1 Camshaft pulley holder for SUBARU



**9G0621**



20/11.2/12.2/0.6'



558g

- Remove or install both the intake and exhaust camshaft pulley without damaging the camshaft or the pulley.
- Application:  
Subaru: 2004-2013 Forester XT  
2006-2014 Impreza WRX  
2004-2018 Impreza WRX STI  
2005-2012 Legacy GT  
2005-2010 Outback XT



### Balancer shaft puller for VAG 1.8 / 2.0

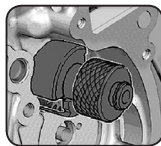

**9G1221**



50/12/13/0.5'



250g

- Use for removing the balancer shaft on 4-cylinder injection engine (1.8, 2.0L - chain drive).
- Internal thread M8 x 1.25 for sliding hammer.
- Application:

VAG 1.8, 2.0 petrol engines in:

Audi: 2015-2017 A1	Seat: 2006-2015 Altea
2007-2017 A3	2010-2013 Exeo
2007-2017 A4	2015-2017 Ibiza
2007-2017 A5	2007-2017 Leon
2012-2017 A6	2007-2017 Toledo
2014-2017 A7	VW: 2013-2017 Beetle
2012-2014 A8	2012-2015 CC
2011-2017 Q3	2008-2015 Eos
2008-2017 Q5	2007-2017 Golf
2015-2017 Q7	2011-2014 Jetta
2014-2017 S1	2007-2017 Passat
2013-2017 S3	2014-2017 Polo
2008-2017 TT	2008-2017 Scirocco
Skoda: 2007-2017 Octavia	2011-2017 Sharan
2008-2017 Superb	2007-2016 Tiguan
2009-2015 Yeti	2015-2017 Touran

- Engine codes:

BZB, CDAA, BPU, BYT, CABA, CABB, CDHA, CDHB, CABD, DAJB, CJSA, CJSB, CJEB, CJEE, CJED, CYGA, DAJA, CDAB, CJSC, CGYA, CAWB, CCZA, CBFA, CCTA, CDNB, CDNC, CFKA, CHJA, CCZC, CPSA, CESA, CETA, CNCD, CYRB, CYRC, CNCE, CYNB, CYPA, CYPB, CULB, CULC, CNCB, CWZA, CJXF, CJXC, CJXB, CJXG, CHHC, CCZD, CJKA, CJKB



**Puller for ribbed drive pulleys**

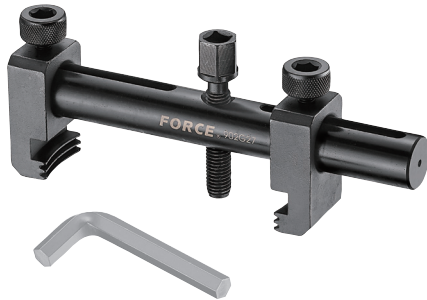

**902G27**

15/19.3/20.3/0.59' 1289g

- This tool helps to remove the crankshaft pulleys without causing damage.
- Suitable for crankshafts, alternators, air conditioning units and water pumps.
- Pulley capacity: 45 to 165 mm.



**FORD / VOLVO Stretchy belt fitting kit**

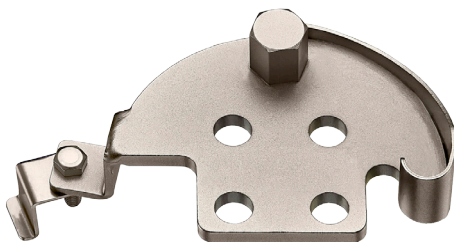

**9G0814**

30/10.8/11.8/0.99' 360g

- Designed to be used where the universal tools will not work due to the double width crankshaft pulley stopping the belt being fitted.
- The tool allows the belt to be easily rotated into place.
- Applicable:  
Ford Fiesta, Focus, C-Max, Mondeo (1.4/1.6),  
Volvo C30, S40, V50 (1.6)



**V-Belt installation tool for BMW**

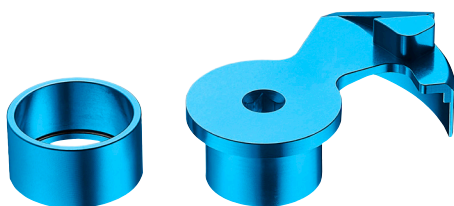

**9G0813**

20/8.3/9.3/0.77' 414g

- Special design to install the V-belt without causing damage.
- Applications:  
BMW N47, N57TU, M47, M47TU, M47T2, M57, M57TU, M57T2.





ENGINE



## Hose clamp pliers kit (Interchangeable)

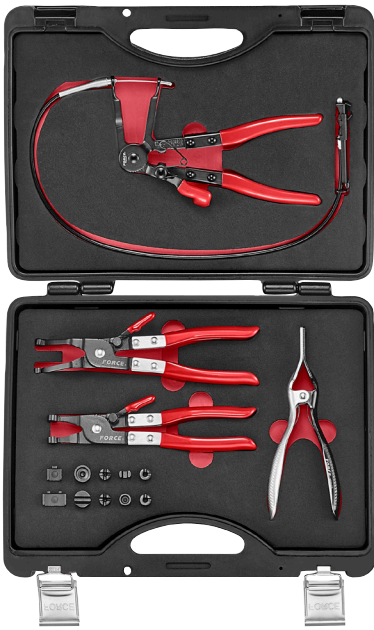

**915G7**

 3/7.3/8.3/1.2'

 2420g

- Straight and angled hose clamp pliers with a selection of interchangeable jaws to remove and install most ring type or flat band hose clamps.
- Flexible hose clamp pliers convenient for work in hidden area or in long distance.

**Contents:**

- 1pc Straight hose clamp pliers
- 1pc Angled hose clamp pliers
- 1pc Flexible hose clamp pliers
- 1pc Hose removal pliers
- 10pc Interchangeable tips

## Hose clamp removal tool

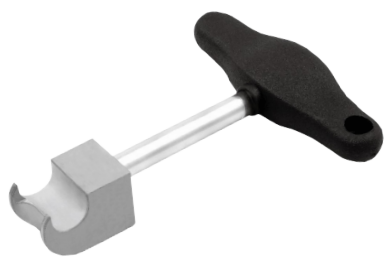

**62532**

 96/12/13/1.78'

 125g

- Universally designed for the loosening / opening of HENN clamps as found on coolant hoses / charge air hoses in passenger cars.
- Application:  
VW-Audi, Seat, Skoda, BMW, Peugeot, Citroen, Dacia, Fiat, Ford, Kia, Lexus, Mazda, Mercedes, Nissan, Vauxhall / Opel, Porsche, Renault, Toyota, Volvo etc.

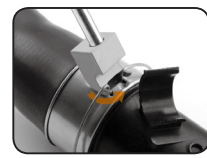

## Heater hose disconnect tool for FORD



**9G0729**

 72/1.2/1.7/0.8'

 15g

- Heater hose connections are in hard-to-reach area and difficult to turn.
- To just clip this tool on and turn makes this job easy.
- Application:  
Ford: Focus 2.0L (12-16), Escape / Kuga 2.0L EcoBoost (13-16).





**Intake manifold release tool for VAG**



**902G29**



144/18.5/19.5/1.7'



101g

- Used for releasing intake manifold pipes.
- Suitable for 1.0, 1.2 and 1.4 direct injection petrol engines.
- Application:  
Audi: A3, Q3 (13~)  
Seat: Leon (13~), Ibiza (13~), Ateca (16~)  
Skoda: Octavia (13~)  
VW: Golf (13~)



**Two way viscous fan spanner**



**9G0710B**



36/21.4/24.5/1.2'



595g

- For the removal of thermo-viscous fans on BMW, Ford, Opel & Vauxhall vehicles.
- Size: 32 mm, 36 mm.

**Radiator / Coolant cap wrench for BMW**



**9G0730**



100/11.1/12.1/0.58'



111g

- Can be used to loosen stubborn caps on radiators and reservoirs.
- Especially suitable for use in narrow spaces.
- Works on BMW vehicles:  
E60, E61, E63, E64, E70, E71, E72, E81, E82, E84, E87, E88, E89, E90, E91, E92, E93, F01, F02, F03, F04, F06, F07, F10, F11, F12, F13, F15, F16, F18, F20, F21, F25, F26, F30, F31, F32, F33, F34, F35, F36, F80, F82, F83, F85, F86.





## Radiator / Coolant cap wrench for FORD / LAND ROVER / MAZDA / VOLVO



ENGINE



**9G0731**



100/6.6/7.6/0.5'

66g

- Can be used to loosen stubborn caps on radiators and reservoirs.
- Especially suitable for use in narrow spaces.
- Application:  
Ford, Land Rover, Mazda, Volvo.



## Vacuum-type cooling system filler kit for Tesla



**903G28**



5/12.2/13.2/3.2'

2496g

- Vacuum-type coolant refill tool has large internal passages to allow coolant to be refilled fast.
- Provided with adapters for all Tesla models.
- Tool is designed with only two valves-easy to use, intuitive design.
- Tool with a hook can hang under the hood.
- Tool needs to work with an air compressor to create a vacuum in the cooling system.



## Coolant refilling funnel set (with extension pipes)



**912G17**



10/8.6/9.6/3.8'

874g

- For anti-spill coolant refilling and air bleeding.
- Includes 4 extension pipes for confined space or tricky angles.
- Transparent lower chamber displays the amount of air bubbles remaining in the radiator.
- Includes adapters with nylon covers to reduce heat transfer resulted from air bleeding.
- Special design of connector to adapters provides anti-spill feature.
- Funnel capacity: 1,600 ml / 54.1 Oz.
- Suitable for passenger cars, trucks and heavy duty vehicles.





**Cylinder leakage tester**



**904G23**

8/21/22/2.0'

2625g

- PSI & BAR percentage gauge
- 26" extra long hose
- Allow you to accurately diagnose engine problems such as bad valves, worn rings.
- Cracked cylinder walls and blown gaskets.
- Works from shop airline and has 10, 12, 14 & 18 mm adaptor fittings to fit most engines.
- Blow-by readings shown in percentage.
- Dual gauges allow mechanic to monitor input line pressure.
- Supplied in plastic blow mold case.
- Gauge: 0-100 PSI 7 bar

**12V Smoke leak detector set**



**923G1**

2/10/10.5/1.65'

4864g

- A Great Tool to trace any leaks in automotive pipe systems such as air intake, fuel system, exhaust system, vacuum system.
- Please use Baby Oil ONLY!!
- Clean the smoke tube with dust gun after each use. The residue hardening baby oil cause clogs in tube.
- Power DC-12V

**Contents :**

- 1pc Smoke machine
- 6pc Rubber pipe plug
- 2pc Inflate ball stopper
- 1pc Smoke tube
- 1pc Power cord
- 1pc Baby oil.

## Diesel engine compression tester kit



**938G2**

 3/13/14/1.8'

 4330g

- Large, 2-1/2" O.D., 70 kg/cm<sup>2</sup> (1000 psi) gauge with rubber bumper, straight and right angled quick connect fittings and an extensive range of glow plug and injector adaptors enable this kit to cover the vast majority of car, van, truck and bus, agricultural and marine diesel engines.
- Glow plug adaptor:  
Wide range of Alfa, BMW, Chrysler, Daewoo, Fiat, Ford, Hyundai, Isuzu, LandRover, LDV, Mazda, Mercedes, Mitsubishi, Nissan, Opel, PSA, Renault, Saab, Suzuki, Toyota, VAG, Vauxhall, Volvo diesel engines.
- Injector:  
M20, M22, M24 & Ford Stanadyne injector plus clamp-on injector.



## Diesel fuel low pressure test kit



**913G9**

 5/20.5/21.5/4.58'

 4338g

- This diagnostic set is to inspect low pressure or return fuel side of diesel engines.
- Two manometers with different scales (-1 - 5 bar and -1 - 15 bar) offer more accurate test results.
- Ten fuel line adapters cover a wide range of diesel engines and car makes.
- Translucent tube on adapters help observe impurities and bubbles in the fuel.
- 2 meter long hoses help connections in confined areas in engine compartment.



ENGINE





**Diesel exhaust fluid (DEF)/AdBlue tester**



**9G4006**



60/12/14/4.2'



192g

- The tool offers quick, easy, and precise measurement of UREA concentration in DEF or AdBlue solution.
- Easy-to-read concentration table on the body.  
(Three floating discs for accurate reading)

**Auto-flexing fuel line socket**



**905G27**



20/9.5/10.5/1.3'



475g

- With Auto-flexing fuel line sockets, you can reach for fuel line nut in narrow space.
- In addition to auto-flexing function, the socket can tight the nut without losing torque.
- Size: 11, 13, 14, 15, 17 mm.
- Max torque: 30 Nm.



**Diesel injector puller adapter master kit**



**921G3**



2/12.5/13.0/0.8'



5920g

- Universal tool kit for disassembling the injector and for preparing the removal of the injector.
- Suits a huge range of vehicles including Mercedes Benz, BMW, VW, Audi, VAG, Volvo, Ford, and Mazda plus many more.

**Contents:**

- 2pc Special bit insert Hex: 7.6 mm, 6.6 mm
- 10pc Pull spindle: IT-M14 x 1.5 mm, IT-M16 x 1.5 mm, IT-M25 x 0.5 mm, IT-M25 x 0.75 mm, IT-M27 x 1.0 mm, OT-M16 x 1.0 mm, OT-M17 x 1.0 mm, OT-M20 x 1.0 mm, OT-M25 x 1.0 mm, OT-M27 x 1.0 mm
- 1pc Universal joint: M18 x 1.5 mm
- 4pc Special socket insert Hex: 25, 27, 29, 30 mm
- 4pc Injector gripper hook: 12, 13.5, 16, 26 mm



## Diesel injector remover kit



**922G8**



3/24.5/25.5/1.2'



8182g

- Universal tool kit for disassembling the injector and for preparing the removal of the injector.
- Suits a huge range of vehicles including Mercedes Benz, BMW, VW, Audi, VAG, Volvo, Ford and Mazda plus many more.

### Contents:

- 2pc Special bit insert Hex: 7.6 mm, 6.6 mm
- 10pc Pull spindle: IT-M14 x 1.5 mm, IT-M16 x 1.5 mm, IT-M25 x 0.5 mm, IT-M25 x 0.75 mm, IT-M27 x 1.0 mm, OT-M16 x 1.0 mm, OT-M17 x 1.0 mm, OT-M20 x 1.0 mm, OT-M25 x 1.0 mm, OT-M27 x 1.0 mm
- 1pc Universal joint: M18 x 1.5 mm
- 4pc Special socket insert Hex: 25, 27, 29, 30 mm
- 4pc Injector gripper hook: 12, 13.5, 16, 26 mm
- 1pc Hammer with sliding head of 1.75kgs (**9G1502**), including adaptor M18x1.5P.

## Slide hammer for diesel injector removal



**9G1502**



10/22.1/23.1/1.1'



2206g

- Total length: 310mmL
- Weight of hammer sliding head: 1.75kgs
- Adaptor: M18x1.5P

## Diesel fuel filter socket for FORD



**9G0123A**



100/17.5/18.5/1'



164g

- For the removal of the diesel fuel filter element from the filter housing.
- Cut-out in the socket wall clears the fuel drain valve.
- Application:  
Ford Transit Custom 2.0TDCI 2016 onwards.
- Size: 1/2"DR. x 32 mm





**Glow plug analyzer**



**885G01**

20/5.2/6.2/1.2'

262g

- The tester helps diagnose the condition of glow plug without removing it from the engine.
- This tester works for 12V system.
- The 6 LED indicate the condition of the glow plug (Short Circuit, Fault, OK, High Resistance, Open Circuit and Low Battery).

**Overhead valve spring compressor**



**62116**

20/8.5/9.5/0.75'

388g

- Overhead valve spring compressor is convenient for removing valve springs or replacing valve stem seals on many cars, trucks and light trucks.
- Valve spring compressor is very suitable for installed cylinder heads, especially vehicles with narrow underhood gaps, and can also be used for bench work.
- The spring jaws of the overhead valve spring compressor can easily clamp and compress the valve spring, making it easier for you to operate.
- The leg is designed with a built in offset to compensate for the spring, keeping the tool vertical and stable during use.
- Two spring adapters fit valve spring retainers up to 40mm in diameter, 7mm ~ 60mm jaw opening, 18.5mm throat clearance.

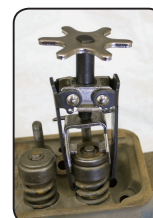

**Valve spring combination tool for BMW B38, B48**



**903G26**

3/19.3/20.3/1.58'

5536g

- For removing and installing valve spring of the intermediate lever and for positioning the sliding block.
- Application: BMW B38, B48

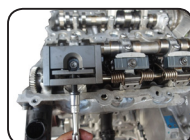

## Air valve lapper



**62114A**

1760g

- Apply five or six droplets oil or motor oil to the air valve lapper through its air inlet port.  
(It is recommended to apply oil from time to time to the valve lapper even during the operation, if the lapper is used continuously for an extended period of time.)
- It's advisable to set air pressure at 6 to 8 kg/cm<sup>2</sup>.  
(85 psi to 100 psi)

**Contents:**

- 1pc Air valve body
- 1pc 16 mm Suction rubber cap
- 1pc 20 mm Suction rubber cap
- 1pc 30 mm Suction rubber cap
- 1pc 35 mm Suction rubber cap



## Piston ring groove cleaner



**62004**

20/8/9/2.1'

400g

- For the removal of carbon deposits from piston ring grooves.
- Suitable for piston sizes from 51 mm to 127 mm.
- Comes with 3pcs-bladed cutters for different groove widths.
- Blade 1 size: 1/16", 5/64", 3/32", 1/8", 5/32", 3/16"
- Blade 2 size: 2, 2.5, 3, 4, 4.5 mm & 1/4"
- Blade 3 size: 1.2, 1.5, 1.8, 2.8, 5, 5.5 mm



## Chain oil filter wrench



**61918**

36/17.5/18.5/1.3'

470g

- For loading and unloading automotive filters.
- Suitable for filters up to 30 mm - 160 mm diameter.
- Chain length 580 mm can be adjusted freely according to different filters.
- Handle length: 225 mm

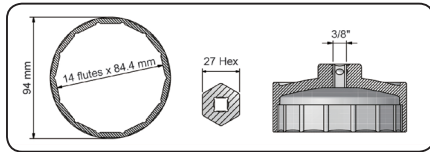

## Oil filter wrench for MERCEDES-BENZ

**6318514**

40/8.5/9.5/2.9'

262g

- Special design for plastic oil filter cap of Mercedes-Benz.
- Size: 3/8"DR. x 84.4 mm x 14PT
- Applicable:
 

E-Class: 2007-2009 W211	2011-2013 W212
M-Class: 2007-2009 W164	2010-2014 W166
R-Class: 2007-2009 W251	2010-2012 W251
S-Class: 2012-2013 W221	
GL-Class: 2007-2009 X164	2010-2016 X166
Sprinter: 2010-2019 2500	2010-2019 3500

## Oil filter wrench for HYUNDAI / KIA

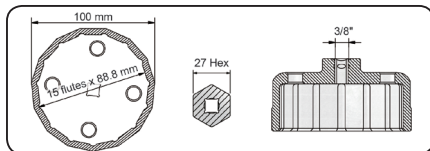
**6318915A**

40/13.5/14.5/2.9'

334g

- Special design for plastic oil filter cap of Hyundai / Kia.
- Size: 3/8"DR. x 88.8 mm x 15PT
- Applicable:
 

Hyundai: 2005-2010 Azera	Kia: 2006-2009 Amanti
2006-2010 Entourage	2006-2014 Sedona
2000-2008 Equus	2006-2017 Sorento
2008-2014 Genesis	
2005-2010 Grandeur	
2006-2010 Santa Fe	
2005-2010 Sonata	
2006-2013 Veracruz	

## Oil filter wrench for BMW

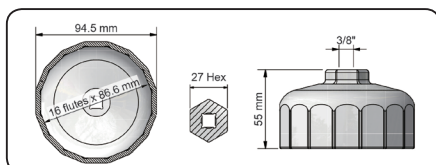
**6318716**

40/9.2/10.2/2.9'

274g

- Special design for plastic oil filter cap of BMW
- Size: 3/8"DR. x 86.6 mm x 16PT
- Applicable:
 

1 Series: E81 (06-12), E82 (07-13), E87 (04-12), F20 (11-20)
2 Series: F22 (12-20), F23 (14-20)
3 Series: E90 (04-11), E92 (05-13), F30 (11-18), F31 (12-19)
4 Series: F32 (13-20), F33 (13-20)
5 Series: E60 (01-10), E61 (04-10), F10 (09-17)
6 Series: E63 (03-10), F12 (10-18)
7 Series: E65 (01-09), F01 (08-15)
X1 E84 (09-15), X3 F25 (10-17), X4 F26 (13-18),
X5 E70 (06-13), X5 F15 (13-19),
X6 E71 (07-14), F16 (14-19)







ENGINE



## 10pc Cup type oil filter wrench kit



**61936**



6/10.8/11.8/1.4'



1792g

- To go with 3/8" or 1/2" drive .
- Adaptor: 1/2"(F) x 3/8"(M)(with 21mm Hex) and 3/8"(F) x 1/2"(M).
- Size: 27/6P, 32/6P, 36/6P, 76/14P, 74/14P (75.6/14P), 86/16P, 76/12P, 93/15P .
- Suitable for Benz, BMW, Volvo, VW, Fiat, Renault, Honda, Mazda, Nissan, Toyota, etc.

## Plastic oil drain plug driver tool set



**904G22**



48/7.7/8.7/0.67'



167g

- For removing and installing of the plastic oil drain plug at the plastic oil pan.
- Application:  
Ford, Peugeot, Citroen, BMW, VW, Audi, Skoda, Seat, Porsche.

### Contents :

1pc Offset bit holder wrench 100 mm. (8152105)

1pc 10 mm Hex bit, 1/4" hex shank. (1242510)

1pc 3/8" Sq. with slot, 1/4" hex shank. (61938)

1pc VAG oil plug bit, 1/4" hex shank. (9U0712)





**Plastic oil drain plug driver tool for FORD / PEUGEOT / CITROEN**



61938				
Part no.	Size	mm	packing	g
61938	1/4"Hex - 3/8"Sq	25	140/1.8/2.8/0.4'	13

- For removing and installing of the plastic oil drain plug at the plastic oil pan.
- Size: 3/8"Sq. with slot, 1/4" hex shank
- Application:  
 Ford: C-Max (15~), Edge (15~17), F-150 (15~16), F-150 (15~19), F-250/350/450/550 Super Duty - diesel (11~12), Focus (14~), Fusion (17~), Galaxy (15~), Kuga (14~), Mondeo (14~), Mustang (15~17), S-Max (15~), Transit/Tourneo Connect (13~)  
 Peugeot: 308 (13~), 3008 (09~), 508 (14~), 5008 (09~), Traveller (16~)  
 Citroen: C4 (13~), C5 (09~15), D84 (14~15), D85 (13~15), Jumpy (16~), SpaceTourer (16~)

**Oil funnel set for VAG**



**906G12**

10/3.5/4.5/1.57' 354g

- Funnel can be directly connected to oil filler necks, eliminating unsafe oil spills.
- Engine oil bottles can be put up side down on funnel-hands-free and one-person operation.
- Large oil passage allows oil to flow down more rapidly.
- Lower transparent chamber shows oil flows down to engine.



**Fuel injector tester**



**885G02**

20/4.9/5.9/1.2' 246g

- Connected with the 12V vehicle battery, the tester generates four different output signal pulses for user to check the condition of the injector when the engine is switched off.
- By using the tester, user can check if the injector is stuck, leaking or burnt-out.
- Operation environment: 0~40°C; < 80% RH
- Storage environment: -10°C~50°C; < 85% RH

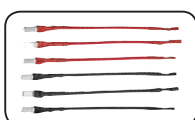

## Fuel injector remover / installer for BMW B36, B38, B48

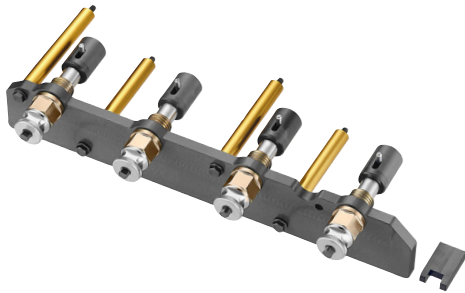

**9G0132**

5/15.7/16.7/1.2'

3150g

- The set is specially designed to install and remove the injector.
- Application:  
BMW B36, B38, B48 engine.



## Fuel injector seal installer / remover for BMW



**908G10**

10/8.7/9.7/1.2'

870g

- Special design for removing and installing the injectors seal (PTFE seal).
- Application:  
BMW: N13, N14, N18, N20, N26, N43, N53, N54, N55, N63, N74, S55, S63, B38, B48

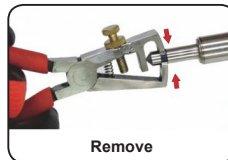

Remove

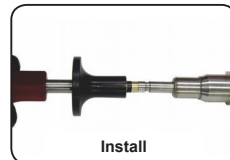

Install

## Petrol injector puller for Bosch - GDI



**9G0133**

10/14.3/15.3/0.67'

1432g

- Pulls Bosch GDI petrol injector straight out, without damaging the injector or head.
- The 2PCS jaw design with slide lock easily accesses and grips recessed injectors.
- Suitable for works on Ford GTDI ecoboost engine from 1.0L to 3.7L and on GM SIDI Ecotec engine from 2009.



**Fuel injector and seal tool kit for BMW**



**908G19**



10/10.3/11.3/0.8'



1049g

- Used to remove fuel injectors and install new seals onto the injectors.
- Applicable:  
BMW: N54, N63 engine.  
Mini Cooper: N14, N18 engines.

**Injector nozzle tool set for BENZ**



**903G25**



60/16.9/17.9/0.65'



282g

- For removing the petrol injector using a slide hammer or T bar.
- For restoring fuel injectors immediately after calibration of the sealing rings.
- For most 4.6 to 5.5 litre petrol engines.
- Application:  
M133, M152, M157, M270, M274,  
M276, M278 engines.



**Button connector pliers with flexible cable**



**9G0209**



36/22.3/23.3/2.8'



502g

- This pliers allows a quick disassembly of 2-button connectors, mainly used for fuel systems, gearbox, brake fluid, urea fluid water, power steering, air system and AC systems.
- Cable length: 650mm
- Jaw open range: 3mm to 32mm





ENGINE



## Fuel line disconnect tool set

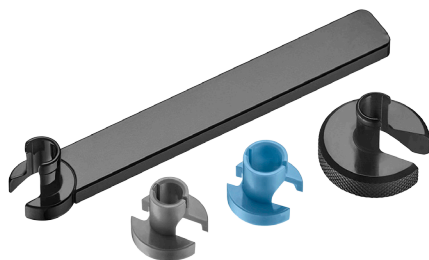

**904G24**

96/13/14/1.7'

125g

- Special design for disconnecting the quick couplings on fuel line of fuel filter.
- Applicable: VAG, Fiat, Jeep, Opel, Ford, Chrysler and Volvo.

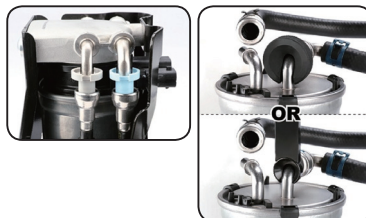

## Fuel return line tool for VAG

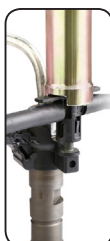

**9G0736**

48/13.7/14.2/1.4'

242g

- Designed for professional removal/installation of the fuel return line PUSH-FIT connector (round type) at the injectors.
- Suitable for VW, Audi, Skoda, Seat 2.0, 2.7 and 3.0 TDI Common rail diesel engine.
- Application:  
Audi: A3, A4, A5, A6, A7, Q5  
Seat: Exeo  
Skoda: Yeti  
VW: Eos, Golf V, Golf VI, Jetta, Passat, Scirocco, Tiguan, Transporter T5, Phaeton

## 3-Jaws adjustable fuel tank lid wrench

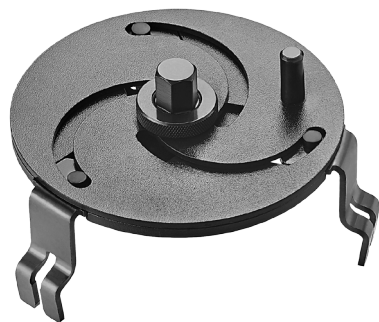

**9G0732**

12/11.5/12.5/1.2'

955g

- Adjustable to suit most collars from 90-170 mm.
- Lock in place and turn with a 16mm wrench or socket.
- An innovative tool for the removal and fitting of fuel gauge sender collars.

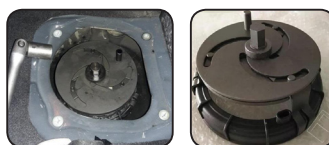



**Diesel filter wrench for VW / VOLVO**



**61937**



96/15/16/1.2'



150g

- Specially designed to fit the plastic housing for removal and replacement of the paper fuel filter.
- Application:  
VW: Crafter 2.5 TDI from 2006 to 2013.  
Volvo: V70, XC70, S40, S60, S80, XC90, V50  
4 and 5 cylinder 2.0lt and 2.4lt diesel engines.



**Fuel filter cover mounting tool for VAG**



**9G0131**



10/10.8/11.3/0.88'



1080g

- The fuel filter cover mounting tool is designed to press the fuel filter cover evenly and in a torsion-free manner into the seal seat in the fuel filter housing.
- Application:  
Audi, Seat, Skoda and VW diesel vehicles with UFI and MANN fuel filter housing.

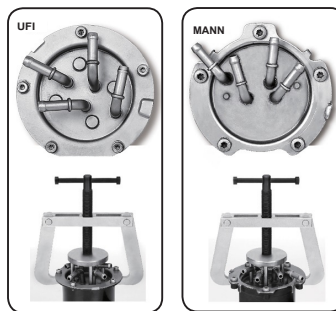

**1/2"DR. Vacuum switch socket**



**443**



*l*



Part no.	size	mm	g	pc/box
44317	17	85	182	10
44322	19	85	230	10
44327	22	85	389	10

- Works on most vehicle EGT and lambda or oxygen sensors.
- A slot provided in the side of the socket allows wire clearance.
- 1/2" SQ. DR., 21 mm Hex DR.









ENGINE

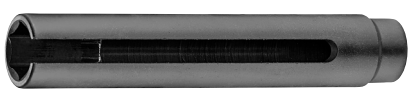

## 1/2"DR. Vacuum switch socket



**443150**   

Part no.	size	mm	g
44315017	17	150	324
44315019	19	150	343

- For removing and installing lambda sensors with a deep-seated hexagon.

## 7pc Slotted socket set



**907G22**  20/10/11/1.2'  498g

- Used for assembling the top and side wired temperature sensors, thermo switches and other components.
- Also can be used for nuts and bolts of bent pipes.

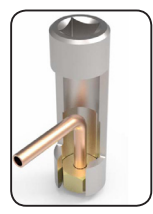

**Contents:**  
 1/4"DR.: 10, 11, 12 mm (423A10/423A11/423A12)  
 3/8"DR.: 13, 14 mm (433A13/433A14)  
 1/2"DR.: 17, 19 mm (443A17/443A19)

## 6pc EGT Sensor socket set



**906G11**  24/15.8/16.8/1.4'  648g

- This set of sockets is designed to remove exhaust temperature sensors.
- Two different styles can remove most EGT sensors used on cars, as well as on light, medium, and heavy-duty trucks.
- Size: 13, 14, 17 mm.

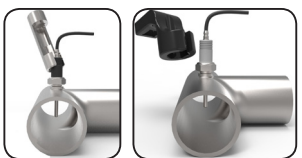



**1/2"DR. Angle impact wrench**



<b>825412</b>	<b>l</b>		
Part no.	mm-inch	g	pc/box
825412	350-13.8"	1960	1

**Specifications:**

Square Drive .....	1/2"
Free Speed (R.P.M).....	4700
Max. Torque (Ft/Lbs) / (Nm).....	170/230
Air Inlet (P.T.) .....	1/4"

- Single hammer impulse device.
- High torque.
- Reversible lever.
- Two power adjustable screwing positions.
- Exhaust through handle.

**Aluminum R1234yf Auto A/C manifold gauge set (with 60" hose 1/4" SAE & 2 couplers)**

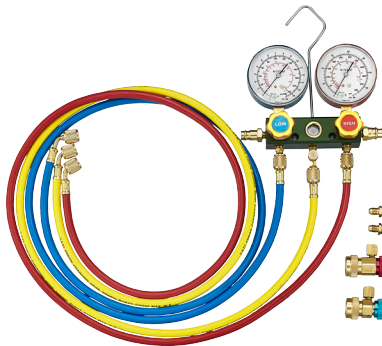

**9G4109**

10/22.0/23.0/2.4' 2200g

- R1234yf sight glass manifold with three 60" 1/4" SAE color-coded hoses and 2 couplers.
- With sight glasses.
- 80 mm Gauge faces for easier viewing.
- High pressure: 0~550 psi  
0~40 bar
- Low pressure: 0~230 psi  
0~16 bar
- Vacuum: 0~30 in/Hg

**R-1234yf Adjustable quick coupler set**

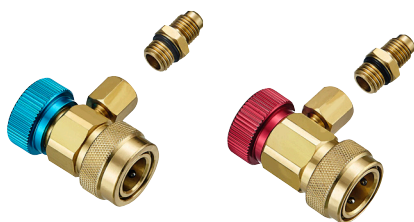

**9G4126**

50/18.4/19.4/1.1' 368g

- Including the high-side and low-side coupler.
- The valve core puller is adjustable to fit the different valve core.



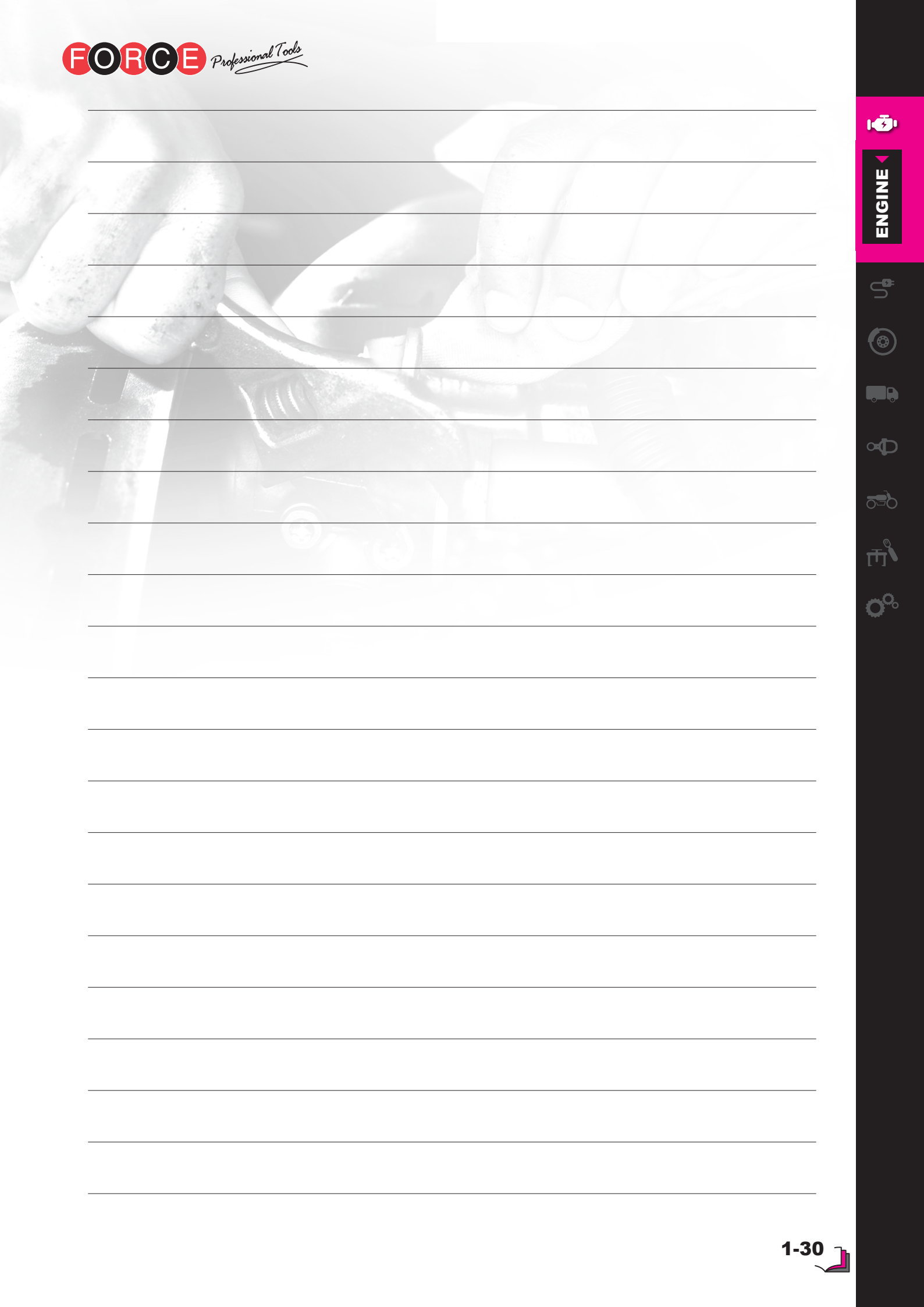

**ENGINE** ◀



**Connector removal tool for VAG**



**9C2010**

72/5.5/6.5/1.27'

75g

- The safe and proper way to remove most VAG push & pull connectors.
- This kind of electrical connector is often found on mass air flow (MAF) sensor, coil packs, headlights/ fog lights, level sensors, MAP sensors, and etc...
- Suitable for VAG group: VW, Audi, Porsche, and etc...



**Vehicle battery tester**



**88439**

12/4.7/5.7/0.96'

392g

- This is a device to test the 12 volt lead-acid battery of any vehicle.
- The tester will focus on health condition analysis of vehicle battery.
- It will estimate the cold cranking ampere (CCA) of the vehicle, and predict the lifetime of the battery.
- This will be helpful for the technician to inspect and maintain the electrical system of the vehicle.
- Base on the inspection, user can predict the time to replace the battery.

**Super mini booster (14AH)**



**885G11**

4/21.7/22.8/1.35'

5425g

- The super mini booster is handy to carry just in case you need to jump start your vehicle.
- Can be used to power accessories, such as your spotlight, air compressor, DVD player, radio, electric fan, electric cooler boxes, even your mobile phone...etc.
- Equipped: 5V USB port x2, two bright LED lights, cigarette lighter DC 12V / Max. 10A, voltmeter.
- Charging power: AC100-240V adaptor / DC 12V via car cigarette lighter, solar panel
- Instant max current: 1200 ampere.
- Battery capacity: Acid battery DC 12V / 14AH.
- Applicable range: Petrol 4~8 cylinder up to 6.5L Diesel up to 3.0L



## Super mini booster (20AH)



**885G12**

 4/30/31.2/1.35'

 7500g

- The super mini booster is handy to carry just in case you need to jump start your vehicle.
- Can be used to power accessories, such as your spotlight, air compressor, DVD player, radio, electric fan, electric cooler boxes, even your mobile phone...etc.
- Equipped: 5V USB port x2, two bright LED lights, cigarette lighter DC 12V / Max. 10A, voltmeter.
- Charging power: AC 100-240V adaptor / DC 12V via car cigarette lighter, solar panel
- Instant max current: 1800 ampere.
- Battery capacity: Acid battery DC 12V / 20AH.
- Applicable range: All 12V vehicles.



## Relay tester



**88438**

 12/4/5/0.96'

 340g

- This is the device to test 3 popular vehicle relays. The testing result will be displayed by led indication
- Technician is able to use the device to figure out the condition of the relay, and so speculating the problem in the vehicle.
- Power supplied: 12V / 24V vehicle battery.
- Support both 4 pin / 5 pin relay.
- Problem pin indication.



**Circuit voltage tester**

**88423A**

100/6/7/3.2'

60g

- Checks 6-24V DC
- Fully shielded indicator bulb.
- Insulated test lead with alligator clip.
- Pointed probe for piercing wires.

**Heavy duty circuit tester**

**88432A**

50/10.5/11.5/2.2'

148g

- Check on 6/12/24V DC systems.
- This can be helpful for tracing faults or adding cables to a circuit.
- 5-ft flexible rubber wire with spring relief.
- Heavy duty insulated alligator clip.

**Digital circuit tester**

**88436**

60/11/12/1.5'

172g

- Features an easy-to-read LCD digital display which shows the accurate voltage value.
- Compatible with most vehicles including: cars, motorcycles, commercial vehicles, trailers, boats, agricultural machinery and mild hybrid vehicles.
- Suitable for testing on 6/12/24/42/48V DC systems.
- With a spring cable which can be extended to 3m (12ft).



## Digital automotive meter

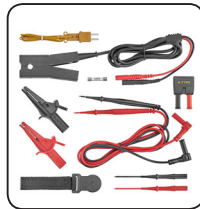

**88445**

 12/11/12.5/1.6'

 844g

- Auto ranging
- Auto power off
- Overload protections
- Safety input jacks
- Safety test leads
- RPM: 600-3200, 6000-12000  $\pm$  2%
- Dwell Angle: 4, 5, 6, 8 Cylinders  $\pm$  2%
- Duty cycle: 0-90% >100us, <100ms  $\pm$  2.0%
- DC Volts: 400mV, 4V, 40V, 400V, 600V  $\pm$  1.0%
- AC Volts: 400mV, 4V, 40V, 400V, 600V  $\pm$  2.0%
- DC Current: 400uA, 4000uA, 40mA, 400mA, 10A  $\pm$  2.0%
- AC Current: 400uA, 4000uA, 40mA, 400mA, 10A  $\pm$  2.0%
- Resistance: 400 $\Omega$ , 4k, 40k, 400k, 4M, 40M $\Omega$   $\pm$  1.5%
- Frequency: 10 Hz - 400kHz  $\pm$  0.1%
- Temperature: -20°C to 1000°C,  
-4°F to 1832°F  $\pm$  2.0% k-Type thermocouple
- Resolution: 1RPM, 0.1mV, 0.1uA, 0.1 $\Omega$ , 1Hz, 0.1°C, 0.1°F
- Diode test
- Continuity test
- Data Hold

## Multi-purpose crimping tool



**6806A**

 40/12/13/1.1'

 258g

- Wire cutter
- Crimping non-insulated terminals: 1.5, 2.5, 4-6 mm<sup>2</sup>
- Crimping open-barrel terminals: 0.5, 2.5, 4-6 mm<sup>2</sup>
- Cutting bolt: M2.5, M3, M3.5, M4, M5
- Crimping insulated terminals: 0.5-1.5, 1.5-2.5, 2.5-6 mm<sup>2</sup>
- Wire stripper: 0.75, 1.0, 1.5, 2.5, 4.0, 5-6 mm<sup>2</sup>  
AWG 20-22, 18-20, 16-18, 14-16, 12-14, 10-12

6pc Insulated extra long hex key set

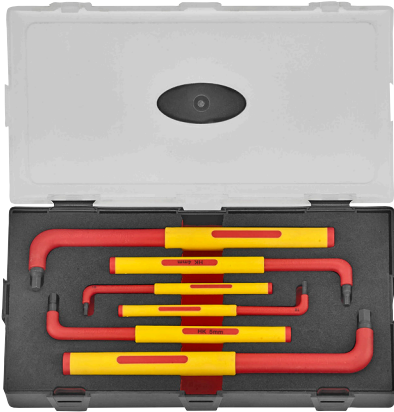

**K50641N**

12/9.46/10.46/1.1' 788g

6pc 2.5; 3; 4; 5; 6; 8 mm

9pc Insulated extra long star key set

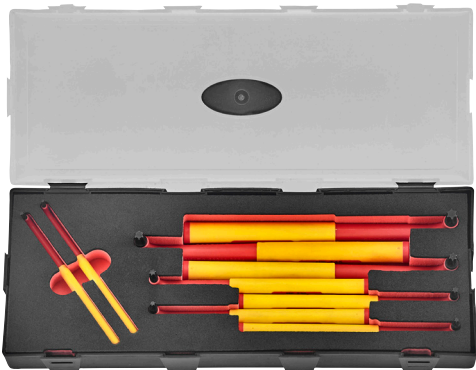

**K50926N**

6/6.9/7.9/0.78' 1152g

9pc T10, T15, T20, T25, T27, T30, T40, T45, T50

Multi-functional pliers



**6915220**

48/17/18/0.9' 286g

- Gripping
- Wire crimping
- Stripping 1.5 & 2.5 mm<sup>2</sup> cable wires
- Superb cutting function

### 3/8"DR. Insulated 6pt. flank socket



<b>535...M</b>		<i>l</i>	
Part no.	mm	mm	g
53506M	6	44.5	24
53507M	7	44.5	25
53508M	8	44.5	26
53509M	9	44.5	27
53510M	10	44.5	27
53511M	11	44.5	28
53512M	12	44.5	29
53513M	13	44.5	32
53514M	14	44.5	35
53515M	15	46	39
53516M	16	46	41
53517M	17	46	49
53518M	18	46	48
53519M	19	46	53
53520M	20	46	55
53521M	21	46	56
53522M	22	46	64
53524M	24	46	66

### 3/8"DR. Insulated 6pt. flank deep socket



<b>53580...M</b>		<i>l</i>	
Part no.	mm	mm	g
5358008M	8	80	49
5358010M	10	80	60
5358012M	12	80	68
5358013M	13	80	73
5358014M	14	80	76
5358017M	17	80	96
5358019M	19	80	110

### 3/8"DR. Insulated hex socket bit



<b>334...M</b>		<i>l</i>	
Part no.	mm	mm	g
33404M	4	64	37
33405M	5	64	38
33406M	6	64	39
33408M	8	64	42
33410M	10	64	52



ELECTRICAL / CABLE



**3/8"DR. Locking extension**



<b>8083...M</b>	<i>l</i>		
Part no.	mm-inch	packing	g
808306M	150-6"	100/14.5/15.5/0.6'	140
808310M	250-10"	50/11.9/12.9/0.52'	228

**3/8"DR. Insulated quick-release ratchet handle 45teeth**



<b>802320M</b>	<i>l</i>	
Part no.	mm	g
802320M	200	312

**Insulated extra long hex key**



<b>764...N</b>		<i>l</i>	<i>l</i>	
Part no.	Tip	short	long	g
764025N	2.5	25	133	15
76403N	3.0	25	133	15
76404N	4.0	35	171	58
76405N	5.0	35	171	58
76406N	6.0	46	216	162
76408N	8.0	46	216	164

**Insulated extra long star key**



<b>766...N</b>		<i>l</i>	<i>l</i>	
Part no.	Tip	short	long	g
76610N	T10	25	133	15
76615N	T15	25	133	15
76620N	T20	35	171	58
76625N	T25	35	171	58
76627N	T27	35	171	58
76630N	T30	35	171	58
76640N	T40	46	216	162
76645N	T45	46	216	163
76650N	T50	46	216	163





ELECTRICAL / CABLE



## Insulated open end wrench



829	Size	<i>l</i>	
Part no.	mm	mm	g
82909	9	107.5	34.6
82911	11	123	53.6
82913	13	144	87.2
82915	15	163	123.2
82916	16	163	117.2
82918	18	180	141
82919	19	180	146.4
82920	20	194	198.8
82921	21	194	195.8
82922	22	194	191.8
82923	23	224	290.8
82924	24	224	293.6

## Insulated scissors (with small breach)



**6982M**



 80/12.7/13.7/3.1'  102g

- Length: 160 mm
- Material: Stainless steel 420
- Surface finishing: Normal polished finish

## Multi-function screwdriver voltage tester



**88411**

 120/3.36/4.36/1.6'  28g

- Test for voltage and continuity 
- By contact method: 110-250 V AC;  
By non-contact method: 110-600 V AC.
- Operates on two LR44, 1.5 V batteries (included)
- CE, GS certified
- Total length: 135 mm, Stainless steel probe: 40 mmL

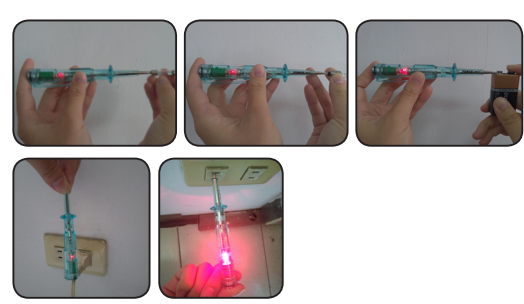

High voltage tester CAT IV 1000V



**88437**



12/11/12/2.2'



910g



- Voltage tester to check for checking the high voltage on hybrid/electric vehicles.
- CAT IV 1000V suitable for both DC and AC voltage testing: DC 6-1000 V / AC 24-1000 V.
- LCD display resolution to 1V. Bar graph displays voltage range 6, 12, 24, 50, 120, 230, 400, 690, 1000 V.
- Includes a self test function, illumination light, voltage value display, phase rotation test, polarity indication, continuity test and non-contact voltage sensing.
- Battery: AAA x 2pc (not included)





**ELECTRICAL / CABLE** ◀



**Multi-function measuring tool**

**9T0109**

20/2.1/2.9/0.88"

60g



- Used for checking thickness of brake pads and brake disc, or depth of tire thread.
- Long-body design making measurement possible without disassembling the wheels and brake calipers.

**Brake disc run-out checking kit**

**903T9**

5/7.55/8.2/0.8"

999g



- Check for ball joint wear and brake disc run-out quickly and easily.
- Locking pliers secured to any convenient position enables DTI gauge to be placed against brake disc.

**Brake disc remover tool**

**9T0108**

5/15/16/1.3"

3000g



- No hammering shock effect on the wheel bearing, electronic sensors, suspension, ball-joint etc.
- The auto adjust jaw let you install the tool easily, quickly, and safely.
- Range: 170-400 mm.

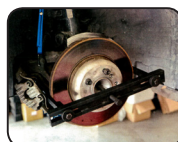

## Wheel hub holding tool

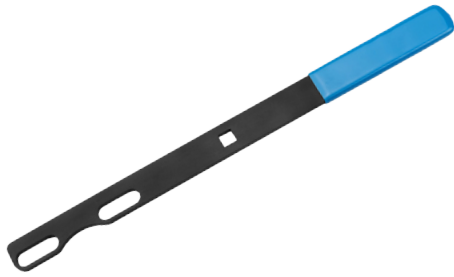

**9T0318**

 50/27.7/28.7/0.77'  553g

- Used to hold the wheel hub in place while the axle nut is removed/installed or during wheel bearing service.
- 1/2" square drive for breaker/extension bar.
- Works on vehicles with wheel stud bolt patterns ranging from 4 x 100 mm (4") to 8 x 170.3 mm (6.7").

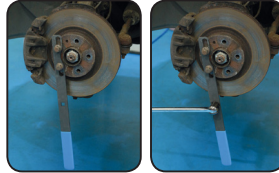

## Brake disc rust removal tool set



**902T6**

 10/9.4/10.4/1.7'  996g









- To remove the rust, corrosion, and lip buildup around the edge of brake discs and hubs.
- Simply fix the handle on the brake disc with the original wheel bolt, hold the scraper on the disc edge, and rotate the handle to remove the rust and corrosion.
- The scraper is able to remove the old silicone on oil pans, carbon buildup on exhaust manifolds etc.
- Finely ground carbide double edges scrape residues off without leaving a damage on the surface.
- Premium tungsten carbide tip remains sharp for an extended period of time.



## Brake bleeder wrench



**9T07**

Part no.	 size	<i>l</i> mm	 g	color
9T0707	7	120	46	
9T0708	8	120	46	
9T0709	9	120	46	
9T0710	10	120	46	
9T0711	11	120	46	
9T0712	12	120	46	



- Built-into-one wrench & socket make the loosening and tightening convenient and easy.
- Ideal for bleeding brake system and hydraulic clutch system without removing the wheels.
- For universal bleeder nipples.
- Internal seal of high quality material for long life.

**12V Brake fluid exchange machine**

**903T10**

1/7/8/2.1'

6340g

- Forced drain function to allow the machine to work with different brake fluid specs.
- Pulsating effect to clean debris in brake system effectively.
- Self purge function is included to prevent air bubble from being introduced into the brake system.
- Automatic shut-off when brake fluid level runs low.
- Buzzer beeps when brake fluid runs low fluid volume.
- Uses car battery as the power source, increasing working flexibility.
- Unique 100% transparent and brake fluid resistant 2 liter tank allows users to see the remaining brake.
- Working Pressure: 1 ~ 2 bar / 14.5 ~ 29 psi.
- Powered by DC-12V

**7pc Brake bleeder adapter set**

**907T9**

10/18/19/2.9'

1908g

- Designed for applications on master cylinder reservoirs from 2001 to today.
- Adapters with a standard european air plug type, suitable for pressure bleeding tools or machines.
- Most adapters have a swivel 90° fitting to tackle limited space problems.
- Applicable:  
Audi, BMW, Chrysler, Citroen, Dodge, Fiat, Hyundai, Jaguar, Jeep, Kia, Land Rover, Mazda, Mercedes-Benz, Mitsubishi, Nissan, Opel, Peugeot, Renault, Toyota, Volkswagen, and Volvo

**Brake pressure bleeder adapter set for TESLA**

**902T5**

20/9.6/10.6/1.07'

524g



- Kit specially designed for performing power brake bleeding on Tesla vehicles.
- Metallic adapter holds pressure up to 2.5 BAR/ 36 PSI.
- Applicable: Tesla Model S, X, 3 and Y



**Universal brake pressure bleeder adapter (Claw Type)**



**9B3502**

 15/7.7/8.7/0.48'  514g

- Brake refilling adapter with a 90° rotating coupling fits almost all vehicles on the market.
- Fits master cylinder fill neck between Ø26-79 mm / 1.0"-3.1".
- Maximum pressure up to 3.5 bar / 50 psi.



**Caliper brake pad socket 15mm x 10pt.**



**9B0402A**

 200/9/10/1.2'  45g



- Application:  
Audi Q7, S8 and Porsche Macan, Cayenne, Cayman
- 3/8"DR. 30mmL
- CR-V, black



**Caliper brake pad socket 20mm x 10pt.**



**9B0402B**

 200/16.4/17.4/1.2'  82g

- Application:  
Audi A8, S6 and Porsche Cayenne
- 1/2"DR. 38mmL
- CR-V, black

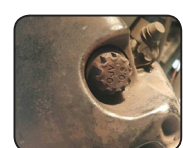

**1/2"DR. 10pt. Socket MS20 (38mmL)**



**9T0211**

 200/17.6/18.6/1.2'  88g

- Special design for tackling the screws on the rear torque frame of HONDA CR-V.
- Size: 1/2"DR. 10pt. Socket MS20 (38mmL)





**Gearless brake caliper pressing tool**



**903T7**

5/13.2/14.2/0.86' 2588g

- Centrally located gearless ratchet for use in tight spaces.
- Evenly spreads in a parallel manner to prevent misalignment of pistons.
- 3 sets of changeable pads for 1, 2, 4, 6 and 8 multi piston calipers.
- Application:  
Pad sets: 90 mm x 60 mm for 1 & 2 pistons  
148 mm x 60 mm for 4 pistons  
180 mm x 60 mm for 6 & 8 pistons

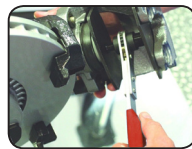

**Foldable & sliding cross socket wrench**



**681F400**

12/15.6/16.6/0.84' 1300g

- Foldable: easy to carry and store.
- Sliding: creates adjustable lever arm to increase power.
- Socket size: 17; 19; 21mm & 1/2"SQ.DR.
- Length: 400 mm

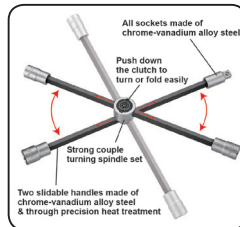

**Mini torque multiplier**



**65108 / 65109**

Part no.	Drive	Torque Ratio	Max. Input	Max. Output	kg
			Nm/Ft-lb	Nm/Ft-lb	
65108	1/2"(F) x 1/2"(M)	1:3.4	176/127	600/443	1.1
65109	1/2"(F) x 3/4"(M)	1:3.4	235/173	800/590	1.1



- Energy-saving tool for tire changing of car and van.
- Small size, light weight, easy to carry & store.
- Supplied with the rubber-covered reaction bar for tire rim protection purpose.
- Accuracy: ±5%.



## Power quick-changing wheel nut set



**911T2**

3/14.0/15.0/1.2' 4666g

- Energy-saving tool designed for car wheel changing.
- Without impact or compressor needed.

### Contents:

- 1pc Torque multiplier head  
Max. Output: 600Nm, Ratio 1:3.4
- 1pc Rubber-covered reaction bar
- 2pc Multiplier output driver 1/2"(M), 3/4"(M)
- 1pc Digital torque adapter 40-350 Nm
- 4pc 1/2"DR. 12pt. Flank impact socket 17, 19, 21, 22 mm
- 1pc 1/2"DR. Adjustable swivel ratchet handle 24teeth
- 1pc Impact adapter 1/2"(F) x 3/4"(M)



Remover



Installer

## 9pc Wheel lock removal impact socket set



**909T7**

12/17.5/18.0/1.4' 1450g

- This set will remove and replace most locking wheel nuts/hub cap locks on GM, Ford, Chrysler.
- Removes and replaces hub caps without causing damage or distortion to the original cap.
- Suitable for American vehicles.

## 1/2"DR. Impact socket MS21, 85mmL for KIA and HYUNDAI



**9T0208**

100/27.5/28.5/1.5' 253g

- Suitable for wheel nuts with special profile 21 mm.
- Application:  
Hyundai i30, Tucson and KIA



BRAKE / TRANSMISSION





**Wheel stud cleaning tool set**



**907T8**

10/6.9/7.9/1.3'

674g

- Quick and easy stud cleaning tool.
- Quick-change brushes.
- Come with a 1/2" drive adapter and six brushes.
- Brush size:  
12 mm (7/16"), 13 mm (1/2"), 14 mm (9/16"),  
16 mm (5/8"), 22 mm (7/8"), 28 mm (1-1/8")

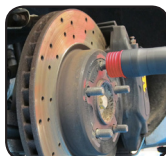

**3-Function digital tire pressure gauge**



**9T0408D**

6/4/5/1.0'

662g

- Includes a 85 cm hose with clip-on chuck and a 5" dual check.
- Functions of quick connection, test, inflator, exhaust and so on.
- Unit selection: PSI, Bar, Kpa
- Pressure Range: 0~200 PSI (13.8 Bar/999 Kpa)
- Accuracy: ±1%.
- Battery: 3V Lithium battery (CR2032)
- Auto sleep after 180s of being idle.

**Rear sub-frame bush remover / installer for BENZ**



**912T7**

3/26.8/27.8/1.5'

7674g

- Removal and installation of rear rubber mounts of axle suspension.
- Application: Benz W204.



## Sub-frame bush remover / installer for BENZ



**921T2**



2/18.9/19.9/1.1'



9450g

- Extractor for replacement of the front and rear metallic sub-frame mounting bushes.
- Application:  
Benz: W211, W219, W230.

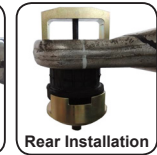
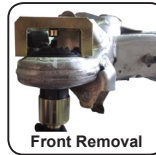

## Differential bush remover / installer for BENZ



**909T8**



3/11/12/0.88'



3680g

- For replacement of the rear sub-frame differential metallic bush.
- Application:  
Benz: W166, W204, W207, W212, W216,  
W218, W221, W222, W231.



## Transmission rubber mount bush remover / installer for BMW X3, X5, X6

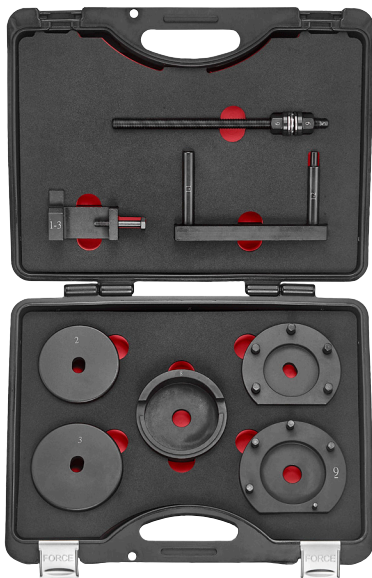

**909T10**



3/23.8/24.8/1.5'



7936g

- Special tool to replace the rubber mount of BMW transmission.
- Applicable:  
BMW: 2004-2010 X3 E83  
2000-2007 X5 E53  
2007-2013 X5 E70  
2008-2013 X6 E71



BRAKE / TRANSMISSION





**Rear suspension bush remover / installer for BMW**



**910T2**

3/24.7/25.7/1.5' 8220g

- Extractor for replacement of the rear suspension mounting bushes.
- Replacement of the mounting bush without completely lowering the rear axle assembly.
- Application:  
BMW E87, E90.

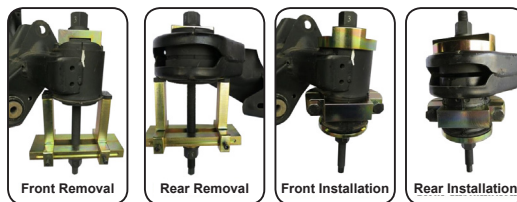

**Differential front bush removal / installation tool kit for BMW**



**907T7**

3/9.8/10.8/0.88' 3250g

- The front differential bushing on the BMW can be removed/installed without removing the differential.
- Application:  
BMW: F01, F02, F04, F06, F07, F10-F13, F18.

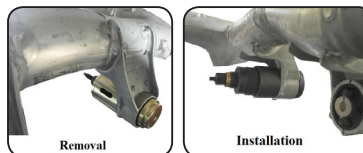

**Differential rear bush removal / installation tool kit for BMW**



**906T8**

3/12.8/13.8/0.88' 4250g

- The rear differential bushing on the BMW can be removed/installed without removing the differential.
- Application:  
BMW: F01, F02, F04, F06, F07, F10-F13, F18.

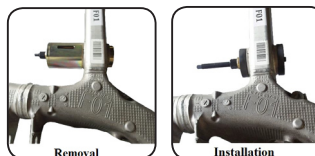

## Rear trailing arm bushing remover / installer for FORD / MAZDA / VOLVO



### 904T10

2/20.5/21.5/1.57' 10220g

- Easy removal and replacement of the rear trailing arm bushes without removing the trailing arm completely from the vehicle.

- Application: Ford: 2003-2007 C-Max CAP  
2008-2011 Focus CB4  
1998-2005 Focus I  
2004-2008 Kuga CBV Focus II  
Mazda: 2003-2008 3-BK  
2005-2010 5-CR  
2003-2009 Axela  
2009- BL  
2005-2010 Premacy CREW/CR3W  
Volvo: 2004-2012 S40 II/V50

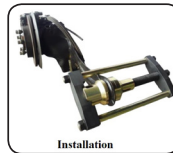

Installation



Removal

## Rear trailing arm bush remover / installer for FORD / VOLVO



### 903T8

2/16.0/17.0/1.15' 8000g

- Suitable for the removal/installation of the rear trailing arm mounting bushes on Ford vehicles.
- Can be used in situ without removing the arm from the vehicle.
- Also suitable for some Volvo vehicles that share the same Ford platform.
- Application:  
Ford: Mondeo Mk IV (07on), S-Max (06on), Galaxy (06on)  
Volvo: S60, S80, XC60, V70, XC70 (06-09) with Ford Platform



BRAKE / TRANSMISSION



**Press and Pull sleeve kit**

**927T2**

1/17.7/18.2/0.9'



17700g

- Universal tool set for extracting and drawing in: Silent bearings, hydraulic bearings, bearing bushes, ball bearings, shaft seals, rubber bearings, etc.
- Full universal application.
- Ideal for different vehicles: Cars + HGVs.
- Depending on requirements, the particular sleeves can also be individually reworked (e.g. recess, etc.)
- Application also with workshop press + press frame.
- Contains 22pcs press-on sleeves  
 Inside: Ø34, 36, 38, 40, 42, 44, 46, 48, 50, 52, 54, 56, 58, 60, 62, 64, 66, 68, 70, 72, 75, 80 mm  
 Outside: Ø44, 46, 48, 50, 52, 54, 56, 58, 60, 62, 64, 66, 68, 70, 72, 74, 76, 78, 80, 82, 85, 90 mm
- Contains 5pcs pulling spindle + nuts  
 Size: M10, M12, M14, M16, M18.

**Custom built bush / bearing / seal driver set**

**952T1**

2/15.6/16.6/0.95'



7800g

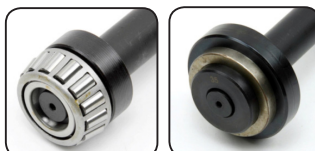

- This master set allows you to build your own custom bushing driver.
- Select the required sizes and assemble your driver tool, to suit the required seal, bush or bearing job.
- Build to suit the required seal, bush or bearing job.
- Disc size: go from 18 mm to 65 mm in 1 mm increments and 74 mm.

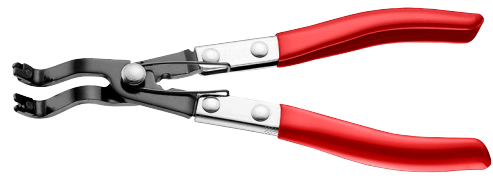

## Wheel bearing circlip pliers



**9T0319**

 48/11.2/12.2/1.5'  230g

- Special design of the pliers' tips enable the easy removal and replacement of wheel bearing circlips without eyelets.
- Applications: Citroen C1 (05-15), Peugeot 107 (05-15), Toyota Aygo (05-15) 1.0 petrol, 1.4Hdi.



## Heavy duty long barrel air hammer



**827M02**

*l*





Part no.	mm-inch	g	pc/box
827M02	220-8.7"	2285	1

### Specifications:

AIR Inlet .....	1/4"
Hose Inlet .....	3/8"
Blows Per Minute (B.P.M.).....	2350
Air Consumption (C.F.M.).....	7.4
Piston Stroke (mm) .....	90
Chisel Shank(mm) (Round).....	10.2

## Hydraulic ball-joint puller



**62822**

 4/17/18/1.0'

 4250g

- The special design and function for dismantling the ball-joint on passenger cars.
- Both of the tools can switch position in tight areas of the wheel suspension.
- The jaw opening can also be turned to fit the ball-joint size.
- Capacity force: 7 ton.
- Jaw opening: 25, 32 mm.
- Fit range: 60-72 mm.





**Drive shaft joint inserter**



**9T0209**

40/8.12/9.12/2'

203g

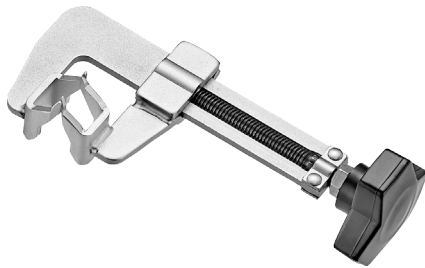

- It is the guide of C-Ring tools.
- Compress the circlip that is spreading, and fix the fixed joint.
- C-ring can be reliably held. It can be assuredly assembled.
- Since it is a screw type, you can easily compress the circlip evenly.
- Total length: 150 mm.
- Max opening: 50 mm.

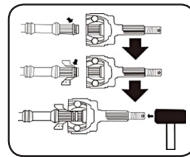

**15-Liter pneumatic/manual fluid extracting/filling**



**9T3613**

2/8.9/11.9/3.92'

4275g



- Large reservoir capacity of 15L designed for daily professional use.
- 3.5ft fluid dispensing hose features brass shut-off valve and connector for use with most common transmission adapters.
- Store and lock pump handle locks in place when stowed for a convenient carry handle.
- Unique design, with the pneumatic extracting and manual filling (draining).
- Working pressure: 70-170 PSI/4.9-11.9 BAR
- Air inlet: 1/4"PT
- Tank capacity: 15 Liter

**Replaceable gasket separator**



**902T7**

100/17/18/0.76'

174g



- Tool for separating old sealant on oil pan.
- High quality SK-5 blade provides satisfactory sealant separation.
- Can also use on cylinder head cover, transmission pan, differential covers and other sealant joints in a vehicle.



## Transmission rubber mount bush installer & remover



**913T3**



3/20.7/21.7/1.2'



6892g

- Special tool to replace the rubber mount bush of BMW transmission.
- Application:  
BMW: E90, E91, E92, E60, E61, F07, F10, F11, F01, F02, E84.
- Transmission type: ATC300, ATC350, ATC35L, ATC450.

## VW / AUDI 7 Speed DSG clutch installer & remover



**909T9**



2/25/26/1.9'



12500g

- This tool is designed to install and remove the clutch of gearbox (0AM, 0CW).
- Application:  
VW: Golf (04~), Golf Plus (05~),  
Touareg (03~) with 6-speed gearbox (code 08D),  
Touran (16~) with 7-speed gearbox (code 0CW)  
Audi: A3 (04~) with 7-speed gearbox (code 0AM)



BRAKE / TRANSMISSION





**DSG Transmission filter wrench for VAG - short version**



**9T0207**

48/12/13/1.78'

250g

- Specially designed to remove and install the transmission filter housing cover when changing the transmission filter on the DSG gearbox in VW, Audi, Skoda and Seat vehicles.
- The oil change can be done without removing the battery, saving time.
- 1/2"DR. x 24 mm x 100 mmL.
- Shorter version available for common rail engines.



**DSG Transmission filter wrench for VAG**



**9T0207L**

48/12/13/1.78'

320g

- Specially designed to remove and install the transmission filter housing cover when changing the transmission filter on the DSG gearbox in VW, Audi, Skoda and Seat vehicles.
- The oil change can be done without removing the battery, saving time.
- 1/2"DR. x 24 mm x 138 mmL.



## 12.5 Liters manual/pneumatic fluid refilling set



**912T8**

2/10/11/3.5'

4724g

- Set for refilling fluids such as ATF, gear oil and differential oil.
- Especially designed for vehicles without a transmission dipstick.
- A combination of pneumatic and manual functions allow energy-saving work and precise refilling.
- 12.5L large tank suitable for transmissions that require large refill volume.
- Adaptor material: Nylon



**BRAKE / TRANSMISSION**



### 3/4"DR. BENZ Star impact socket (E30)



Part no.	Size	mm	packing	g
46611030	E30	110	30/26/27/0.4'	800

- Application range:  
Mercedes Bus (405), Unimog (437), Econic (956), Actros (963), Arocs (964), Atego (967), Zetros (949)

### BENZ Truck filter wrench 46mm



<b>61939</b>		100/21.5/22.5/1.0'		250g
--------------	---	--------------------	---	------

- To remove the oil filter of Benz truck.
- Size: 3/8"DR. 6 point, 46 mm.
- Application:  
Benz Truck Actros, Atego, Axor and Econic...

### 3/4"DR. SCANIA Star impact socket



Part no.	Size	mm	packing	g
46611032	E32	110	30/26/27/0.4'	869

- To remove and install the bolt of crankshaft bearing cap.
- Applicable: Scania Ti engine.

### 3/4"DR. MAN Star impact socket for HGV Cylinder head bolt E22



Part no.	size	mm	packing	g
46611022	E22	110	30/17.4/18.4/0.4'	580

- For HGV cylinder head bolts.
- Applications:  
For MAN new TGA engines.

## SCANIA Radiator quick adapter



**9G0733**

 80/12.4/13.4/1.2'

 138g

- Specially-designed female adapter for radiator when purge & refill radiator liquid.
- Application: Scania (340/360) trucks and buses.



## VOLVO (FM12) valve spring compressor tool



**62115**

 10/20/21/1.8'

 2000g

- For assembly and disassembly of valve springs and valves.
- Application: Volvo FM12.



## VOLVO (FM12) truck injector sleeve remover / installer set



**904T9**

 6/20/21/1.0'

 3340g

- This tool is designed for installing and removing sleeve.
- You need this tool to change the sleeve, when the truck seems powerless or it smokes with black clouds.
- Application: Volvo FM 12 Truck.

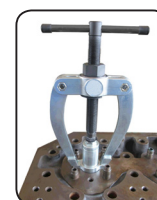

## VOLVO Radiator quick adaptor



**9G0735**

 80/12.4/13.4/1.2'

 155g

- Specially-designed female adapter for radiator when purge & refill radiator liquid.
- Application: Volvo trucks.





**9pc Sockets for ball bearing nuts (outer teeth)**



**909T3**

3/18.3/19.3/0.88' 5.8kg

- Outer-teeth sockets for ball bearing nuts.
- 1/2": KM 4, 5, 6, 7
- 3/4": KM 8, 9, 10, 11, 12

Size	Ø	slot	Length
KM4	Ø32	4	55
KM5	Ø38	5	55
KM6	Ø45	5	55
KM7	Ø52	5	55
KM8	Ø58	6	68
KM9	Ø65	6	68
KM10	Ø70	6	68
KM11	Ø75	7	68
KM12	Ø80	7	68

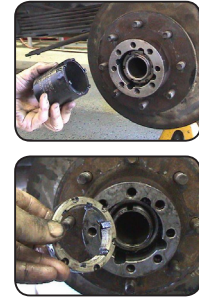

**Socket for ball bearing nuts (outer teeth)**



**9TS4KM**

1/2"DR.

Ø **1**ut slot

*l*



Part no.	Size	mm	mm	mm	g	pc/box
9TS4KM04	KM4	32	4	55	176	1
9TS4KM05	KM5	38	5	55	184	1
9TS4KM06	KM6	45	5	55	228	1
9TS4KM07	KM7	52	5	55	294	1



**9TS6KM**

3/4"DR.

Ø Nut slot

*l*



Part no.	Size	mm	mm	mm	g	pc/box
9TS6KM08	KM8	58	6	68	560	1
9TS6KM09	KM9	65	6	68	734	1
9TS6KM10	KM10	70	6	68	828	1
9TS6KM11	KM11	75	7	68	954	1
9TS6KM12	KM12	80	7	68	1074	1
9TS6KM13	KM13	85	7	68	1164	1
9TS6KM14	KM14	92	8	68	1240	1

**3/4" Manual impact driver**



**8176**

20/23/24/0.44' 1195g

- Instant impact force loosens rusted or frozen fasteners without damaging them.
- This also can be used for tightening bolts or nuts firmly while being reversible in direction.
- Clockwise and counterclockwise drive direction.



## Wheel stud service kit



### 911T3



2/20.0/21.0/1.1'



9996g

- Provides fast and effective removal and installation of even the-most-seized wheel studs on most disc and drum brake applications.
- Eliminates the risk of damage to hubs, seals, wheel bearings, and wheel studs.
- Application: For use on disc and drum brakes.



## Slugging wrench for brake caliper screw



### 793A6



Part no.	size	packing	g
793A618	3/4"DR. x E18	30/14.6/15.6/0.73'	488
793A620	3/4"DR. x E20	30/15.6/16.6/0.73'	520
793A624	3/4"DR. x E24	30/16.9/17.9/0.73'	564



### 793A9



Part no.	size	pscking	g
793A924	3/4"DR. x M24	30/16.4/17.4/0.73'	546
793A926	3/4"DR. x M26	30/15.9/16.9/0.73'	530

- This tool is designed to loosen/tighten the brake caliper screw connections on commercial vehicles.
- Correct tightening of screws with torque wrench in accordance with the manufacturer's specifications. (Engraved with a torque conversion formula).
- Applications:
  - 793A618: MAN TGL/TGM
  - 793A620: MAN TGL/TGM
  - 793A624: MAN TGA/TGS/TGX
  - 793A924: SAF
  - 793A926: DAF XF/XF95/XF105/XF106





**3pc Seam splitter set**



**903M2**

20/22/23/1.7'

1092g

- Separates spot welded or bonded panels easily.
- Sharpened on three edges allowing a side impact blow to separate the panels.
- The 90° angled tool allows access in difficult areas.



**7pc Mini precision hammer set**



**907M2**

20/5/6/0.85'

248g

- The kit includes interchangeable screw-on tips, including aluminum round, steel round, rubber round, plastic flat, brass round and brass flat tips.
- The dual head gives the user two striking ends to knock down high spots on dent repairs.
- Blowback is eliminated thanks to the dual flex neck that cushions each strike.
- The tool can be flipped over to use the chiseled end for prying off door trim panels or removing glue residue.



**Bumping mallet**



**9M1502**

20/13/14/2.3'

688g

- Mallet with special rubber filler that is elastic in nature, but hard when in use.
- For pushing in and fixing vehicle door weatherstrips, fender flares, and bumpers.
- Avoid scratching and damaging bumpers, panels, and car body in general.





## Manual operation dent puller



**912M1**

12/3.4/4.4/0.97'

284g

- Ideal for repairing the small damage on vehicle bodies.
- Aluminum body and adjustable brackets with plastic protection for high quality & long life.
- Manual operation - economic, safe, easy and quick.
- Used with a hot glue gun.
- With 10pc glue pads.



## 5pc Body filler applicator set

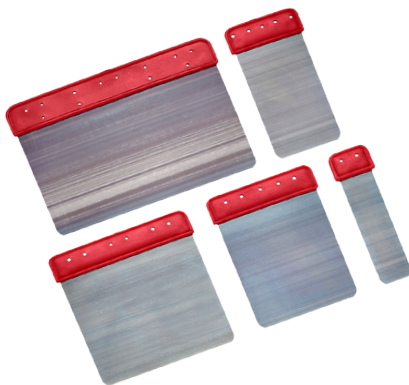

**905M8**

96/13.5/15.0/0.7'

126g

- Made from spring steel with plastic handles.
- Perfect for the application of body fillers in automotive restoration.
- Set includes: 1", 2", 3", 4" & 6" blade sizes.

## Plastic molding strip wedge with handle



**9M0112**

36/8.6/9.6/2'

256g

- 3" non-marring blade allows the technician to remove body side moldings and emblems quick and clean.
- Durable plastic handle can be hit with a hammer and won't mark or scratch vehicle finish.
- Also for the basic opening of car door for insertion of lock our tools.



AUTO BODY



**Door-handle removal and installation tool for VAG**



**9M0110**

72/7.3/8.3/1.6'

75g

- Used for removal and installation of the exterior door handle.
- Application:  
Audi: Q2 (16~)  
VW: Arteon (17~), Atlas (17~), Caddy (16~), Passat (15~), Golf Sportsvan (15~), Tiguan (16~)

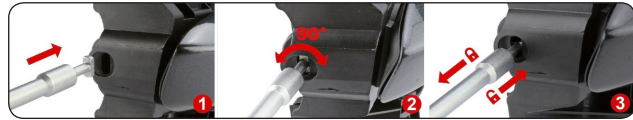

**Roof-grab-handle release tool for VAG**



**9M0111**

72/14/15/2.8'

152g

- For removing the roof grab handle without damage.
- Application:  
Seat: Ateca (16~)  
Skoda: Octavia (13~)  
VW: Golf (13~), Golf Estate (14~), Tiguan (16~)



**Windshield wiper arm puller for BMW**



**9M0208**

30/16.7/17.2/0.4'

550g

- Windscreen wiper arm remover for BMW with adjustable support arms for a wide range of models.
- Application:  
BMW:  
E12, E21, E23, E24, E28, E30, E30C, E31, E32, E32/3, E34, E36, E36/2, E36/3, E36/5, E36/7, E36/C, E38, E38/3, E39, E39PL, E46, E46/16, E46/2, E46/3, E46/5, E46/C, E52, E53, E60, E65, E66, E67, E85, RR1.



## Windshield-washer-nozzle adjustment tool for BENZ

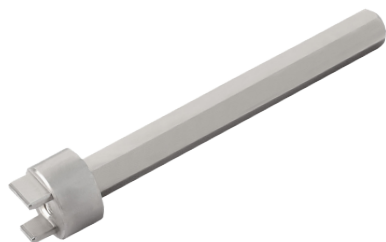

**9M0209**

 288/7.8/8.8/1'

 20g

- For adjusting the fan washer nozzles of the window cleaning system.
- Application:  
Mercedes Benz: W204, W207, W212, W218



## Headlight adjusting wrench for BENZ / AUDI



**9M0109**

 50/9.9/10.9/0.4'

 190g

- The wrench is especially suited to areas with very restricted access.
- For adjusting the headlights or clearance from bumpers and bonnet on Audi A7 and Mercedes C-class / W205 - 2014 onwards.
- Size: 3/8"DR. x H14 x L190 mm.



**AUTO BODY**



**Flywheel puller with external threads**



**9Y0189**

36/21.5/23/2.1'

600g

- For removal of motorcycle flywheels with internal threads.
- Threads M10, M14, M16, M18, M24 are right-handed, M27 are left-handed.

**Advantages:**

- The tool has 6 different sizes of external threads, thus enabling coverage of the majority of motor types that have a flywheel with an internal thread.
- Allows flywheel removal without pulling motor from the hull.
- On each axis, there is an attachment for an open-end wrench that makes the removal of the magnet easier.

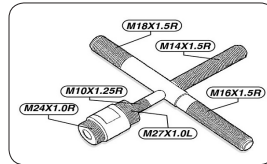

**Spoke wrench**



**608A**

Part no.	size	<i>l</i> mm	packing	g
608A0809	8 x 9	130	600/26.7/27.7/0.65'	42.8
608A0910	9 x 10	130	600/27.0/28.0/0.65'	43.5
608A1011	10 x 11	130	600/27.2/28.2/0.65'	43.6

**Adjustable T-shaped hex socket driver**



**77409B**

Part no.	Tip	<i>l</i> blade	<i>l</i> width	g	pc/box
77409B	9	240	200	252	10

## 3/8"DR. Ratchet impact wrench



**82431**

*l*



Part no.

mm-inch

g

pc/box

82431

250-10"

1298

1



### Specifications:

Length: Square Drive .....	3/8"
Free Speed (R.P.M.) .....	160
Max Torque (ft/lbs) / (Nm) .....	74 / 100
Air Pressure (PSI) .....	90
Air Inlet (P.T.) .....	1/4"
Air Consumption (C.F.M.) .....	7.1



**MOTORCYCLE**





**Tone control torques wrench**



<b>647...K</b>	Capacity	<i>l</i>		
Part no.	Nm	mm	packing	g
6472275K	1/4"DR. 5-25	275	24/19.44/20.27/1.62'	595
6473275K	3/8"DR. 5-25	275	24/20.40/21.32/1.62'	595
6473370K	20-110	370	24/25.68/26.51/1.62'	830
6474450K	1/2"DR. 42-210	450	12/19.56/20.51/1.30'	1316
6474570K	70-340	570	12/23.98/25.02/1.86'	1658
Part no.	Inch-lb	mm	packing	g
6472275KS	1/4"DR. 55-250	275	24/19.44/20.27/1.62'	595
6473275KS	3/8"DR. 55-250	275	24/20.40/21.32/1.62'	595
Part no.	Ft-lb	mm	packing	g
6473370KS	3/8"DR. 15-80	370	24/26.16/27.01/1.62'	830
6474450KS	1/2"DR. 30-150	450	12/19.44/20.18/1.30'	1316
6474570KS	50-250	570	12/23.98/25.02/1.86'	1658

• Spare part available

# Tone control torque wrench



Unlock





Hold & Adjust

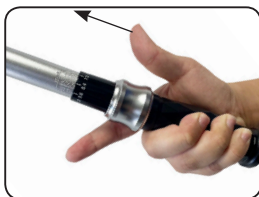

Lock



647...J	Capacity	<i>l</i>		
Part no.	Nm	mm	packing	g
6472030J	1/4"DR. 6-30	281	24/18.96/19.79/1.41'	530
6473030J	3/8"DR. 6-30	281	24/17.76/18.55/1.41'	530
6473110J	20-110	361	24/23.04/23.90/1.62'	770
6474210J	1/2"DR. 40-210	461	12/18.12/18.86/1.30'	1250
6474350J	50-350	553	12/21.84/22.85/1.86'	1590
6476600J	3/4"DR. 100-600	1010	2/12.79/13.93/1.53'	4730
6476800J	150-800	1200	2/14.11/15.24/1.53'	5990
64761000J	200-1000	1200	2/15.20/16.35/1.53'	5990
64781000J	1"DR. 200-1000	1200	2/15.36/16.61/1.53'	5990
Part no.	Inch-lb	mm	packing	g
6473030JS	3/8"DR. 55-250	281	24/18.24/19.18/1.41'	530
Part no.	Ft-lb	mm	packing	g
6473110JS	3/8"DR. 15-80	361	24/22.8/23.66/1.62'	770
6474210JS	1/2"DR. 30-150	461	12/18.36/19.16/1.30'	1250
6474350JS	50-250	553	12/21.84/22.85/1.86'	1590
6476600JS	3/4"DR. 100-450	1010	2/13.00/14.15/1.53'	4730
6476800JS	100-600	1200	2/14.21/15.34/1.53'	5990
64781000JS	1"DR. 150-750	1200	2/15.19/16.33/1.53'	5990

• Spare part available



**PULLER / TORQUE WRENCH**





**Digital torque wrench**



**647G**

- Buzzer and LED indicator.
- Mode: Peak, Track.
- Auto sleep after 120s of being idle.
- USB Data out.
- CW/ CCW Direction.
- Accuracy: CW±1% / CCW ±1.5%
- Memory: 100 Readings.
- Unit selection: Nm, Ft-lb, In-lb, kg-m.
- Battery: 1.5V AA Batteries x 3 (not included)

• Spare part available

647G	Part no.	DR.	Torque Range			<i>l</i> mm	 g
			Nm	Ft-lb	In-lb		
	647G2360	1/4"	3-30	2.21-22.13	26.5-265.5	0.30-3.05	360 1012
	647G3440	3/8"	10-100	7.3-73.7	88-885	1.02-10.20	440 1214
	647G4640	1/2"	35-350	25.8-258.1	309.75-3097.5	3.57-35.7	640 1928

**Digital torque angle wrench**



**647G...A**

- Torque angle: 1°-180°
- Buzzer and LED indicator.
- Mode: Peak, angle & peak, Track.
- Auto sleep after 120s of being idle.
- RS-232 Data out.
- CW/CCW Direction.
- Accuracy: CW±1% / CCW ±1.5%
- Memory: 50 Readings.
- Unit selection: Nm, Ft-lb, In-lb, kg-m.
- Battery: 1.5V AA Batteries x 3 (not included)



• Spare part available

647G...A	Part no.	DR.	Torque Range			<i>l</i> mm	 g
			Nm	Ft-lb	In-lb		
	647G2360A	1/4"	3-30	2.21-22.13	26.5-265.5	0.30-3.05	360 1012
	647G3440A	3/8"	10-100	7.3-73.7	88-885	1.02-10.20	440 1214
	647G4640A	1/2"	35-350	25.8-258.1	309.75-3097.5	3.57-35.7	640 1749

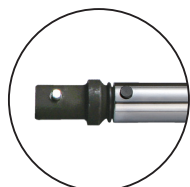

## Interchangeable torque handle (Adjustable torque)



<b>647B1000D</b>		Torque	<i>l</i>	
Part no.	mm	Nm	mm	g
647B1000D	20 x 28.5	200-1000	1100	5460

## 1/2" Digital torque adapter



**647G4075**  48/18.2/19.2/1.7'  290g

- Converts any ratchet or breaker bar into a digital torque wrench.
- Displaying torque value when pressure is applied.
- Highest torque value displayed after load is released (PEAK mode).
- Accurate within  $\pm 2\%$ .
- Torque range: 30 to 260 Ft-lb, 40 to 350 Nm.
- 180 degrees swivel screen.
- LED backlight.
- 10 memory settings.
- Unit selection: Nm, Ft-lb, In-lb, kg-m, kg-cm.
- Length: 76 mm.
- Battery not included.



## 3/4" Digital torque extension



**647G6250**  12/22.0/25.4/2.4'  1874g

- Converts any ratchet or breaker bar into a digital torque wrench.
- Displaying torque value when pressure is applied.
- Highest torque value displayed after load is released. (PEAK mode)
- Accurate within  $\pm 2\%$ .
- Torque range: 52 to 600 Ft-lb (70 to 813 Nm).
- LED backlight.
- 10 memory settings.
- Unit selection: Nm, Ft-lb, In-lb, kg-m, kg-cm.
- Length: 255 mm.
- Battery not included



**PULLER / TORQUE WRENCH**





**Torque handle fittings**



**647H**

**60 Teeth ratchet head (20 x 28.5 mm)**

Part no.	DR.
647H620	3/4"
647H820	1"



**685A20**

**Box end wrench head (20 x 28.5 mm)**



Part no.	size (mm)
685A2036	36
685A2041	41
685A2046	46

**Mini torque multiplier**



**65108 / 65109**

Part no.	Drive	Torque Ratio	Max. Input	Max. Output	
			Nm/Ft-lb	Nm/Ft-lb	
65108	1/2"(F)x 1/2"(M)	1:3.4	176/127	600/443	1.1
65109	1/2"(F)x 3/4"(M)	1:3.4	235/173	800/590	1.1

- Energy-saving tool for tire changing of car and van.
- Small size, light weight, easy to carry & store.
- Supplied with the rubber-covered reaction bar for tire rim protection purpose.
- Accuracy: ±5%.



## Blind hole bearing puller and slide hammer set



**915T1**



4/20.0/21.5/2.2'



5125g

- Two-function bearing remover for puller and slide hammer.
- One slide hammer, 62 mm tailpipe expanders and pullers for 8-55 mm.



PULLER / TORQUE WRENCH





**9pc 1/4"DR. Universal deep socket set**



**20919**

36/14.7/15.7/0.94' 408g

9pc 5; 6; 7; 8; 9; 10; 11; 12; 13 mm (65 mmL)

**Flexible extension tube**



**804...F**

	Size	<i>l</i>	
Part no.	DR.	mm	g
8043200F	3/8"	200	260
8044200F	1/2"	200	272



- Helps access to hard-to-reach corners.
- Delivers high torsion

**Micrometer**

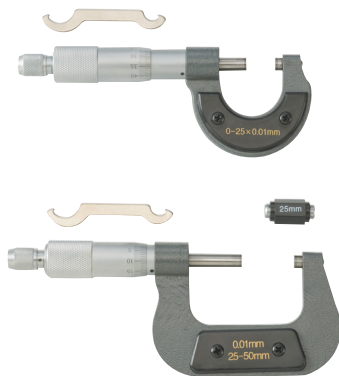

**5096P9...A**

	Range	
Part no.	mm	packing
5096P9025A	0-25	50/15.0/16.0/0.6'
5096P9050A	25-50	50/25.0/26.0/0.8'
5096P9075A	50-75	30/24.0/25.0/1.2'
5096P9100A	75-100	25/20.0/21.0/1.0'

- Precision: 0.01 mm, reading: 0.001 mm

## Refill pressure sprayer



**9U0207**

12/3.5/4.5/1.0'

290g

- Ideal for lubrication, paint, clean dust, antirust, etc.
- Long type nozzle suitable for narrow & difficult space spray.
- Refill pressure with universal adapter for easily to stuff air pressure.
- Build in safety valve pre-setting 90 PSI (6.3 Bar).
- Aluminum canister for long life use.
- Max. Capacity: 650 cc.



## Adjustable tap / extractor holder



**818B**

Part no.	DR.	Size (S)	Capacity (C)	
		mm	mm	g
818B03	3/8"	34.5	3-8	220
818B05	1/2"	38.5	6-12	265

- Used with reversible ratchet handles or T-handles.
- Chuck mechanism hold compatible tap drills and screw extractors.

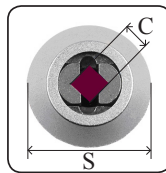

## 1/2"DR. Twist socket



**9US4**

Part no.		<i>l</i>	
	size	mm	g
9US418	18	38	98
9US420	20	38	102
9US422	22	38	110
9US424	24	38	112
9US428	28	40	130
9US430	30	44	186
9US432	32	44	276
9US433	33	44	266
9US434	34	44	276
9US436	36	44	278

- Remove damaged bolts or rounded fasteners.





**12pc Damaged-nut/bolt extractor set**



**912U8**

100/9.4/11.3/1.69' 65g



- The kit is made up of 12pcs cleverly-designed hexagon bolt and nut extractor adapter caps.
- The caps fit over the rounded-off fixing and make a standard 12 point socket or ring wrench applicable to remove the rounded-off hexagon fitting.
- Size: 8, 9, 10, 11, 12, 13, 14, 15, 16, 17, 18, 19 mm.



**26pc 3/8" Manual impact driver & twist socket set**



**3263**

12/20.3/21.3/2.2' 1694g



- Instant impact force loosens rusted or frozen fasteners without damaging them.
- This tool set can also be used for tightening bolts or nuts firmly after being reversed in direction.
- Clockwise and counterclockwise drive direction

**Contents :**

- 1pc 3/8"DR. Manual impact driver (8173)
- 9pc 3/8"DR. Twist socket:
  - 10, 11, 12, 13, 14, 15, 16, 17, 19 mm
- 1pc 8mm Straight rod
- 1pc Bit holder 3/8"DR. x 5/16"(F)
- 14pc 5/16" Bit
  - Phillips PH.2, PH.3 (36mmL)
  - Pozidriv PZ.2, PZ.3 (36mmL)
  - Slotted 9, 11 mm (36mmL)
  - Hex 6, 8, 10 mm (36mmL)
  - Star T25, T30, T40, T45, T50 (35mmL)



## 25pc Screw extractor / drill & guide set



**925U2**

24/17/18/1'

696g

- Fluted type extractors that provide a solid grip on broken studs and screws.
- These screw extractors do not expand the screw while turning and their special design ensures a positive grip when driven into the drilled out hole.
- Drill size is stamped on each extractor for ease of identification.
- Range: 1/4" to 5/8" (6 to 16 mm)

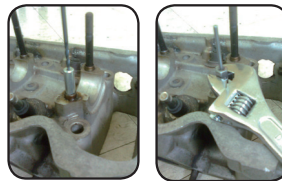

## 3/4" Manual impact driver



**8176**

20/23/24/0.44'

1150g

- Instant impact force loosens rusted or frozen fasteners without damaging them.
- This also can be used for tightening bolts or nuts firmly while being reversible in direction.
- Clockwise and counterclockwise drive direction.



## 3/8" Manual impact driver

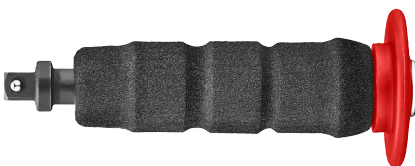

**8173**

30/9/10/0.62'

302g

- Forward and reverse drive direction.
- Instant impact force loosens rusted or frozen screws without damaging them.
- Comfortable handle for anti-vibration.
- Length: 145 mmL



GENERAL

**Professional heavy duty pneumatic rivet gun**



**678A01**



5/14.6/15.6/2.65'



2880g

- Powerful traction force:  
18,200 N (18.2 kN) at 6.2 bar or 4,100 lbf at 90 psi compressed air pressure.
- Long stroke: 18 mm or 0.71"
- Shock-reducer design to minimize tool jumping and hand fatigue.
- Patented rivet-size-hole gauge design to avoid picking blind rivets and working nosepieces of wrong sizes.
- Nosepieces storage design to avoid missing nosepieces.
- Twin air inlet design for right-handed or left-handed users.
- PAHs-free (non-toxic) soft plastic hand grip for safe and comfortable operation.
- Riveting capacity:

Rivet Diameter \ Rivet Material	Aluminum	Steel	Stainless Steel/Inox
3.0/3.2 mm or 1/8"	▲	■	●
4.0 mm or 5/32"	▲	■	●
4.8/5.0 mm or 3/16"	▲	■	●
6.0 mm	▲	■	●
6.4 mm or 1/4"	▲	■	●

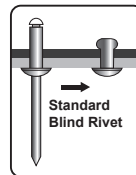

**Electrician folding knife**



**68021**



100/8.4/9.4/1.8'



64g

- Length: unfolded 210 mm / folded 122 mm





## Ultra-slender utility knife



**5055P403**

 100/15.2/16.2/1.42'  134g

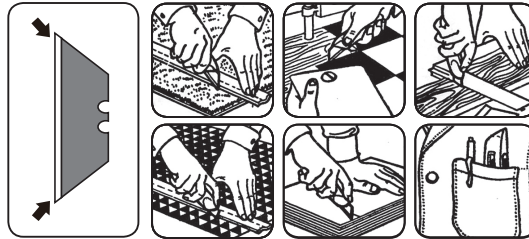

- Retractable blade can be adjusted to 3 positions, will not slip.
- With double point blades.
- For cutting thin plywood, carton, leather, rubber, carpet, etc.
- Spare blade available, item number: 5055P401-P



## Hose cutter



**6930240**

 50/6.3/7.3/1'  100g

- Length: 240 mm
- Size: 6-58 mm O.D.

## Alloy steel pvc pipe cutter (V-blade)



**65607A**

 50/22/23/2.3'  373g



- Kit for 42mm O.D. PVC pipe.
- Less effort.
- Quick release open steel blade.
- Locking catch.



## 90° Corner pipe wrench



**684D**

Part no.	Size	Working capacity	<i>l</i>	 packing	 g
	inch	mm			
684D13	1	0-42	340-13.4"	20/15.8/16.8/0.50'	790
684D17	1-1/2	0-60	440-17.0"	10/14.5/15.5/0.62'	1450
684D22	2	0-70	560-22.0"	10/23.5/24.5/0.96'	2350



**LED COB Slim work light (nature white + yellow light)**



**68611Y**

20/9.9/10.7/2'

378g

- Lumen switch: turn for on/off, and then turn right or left for necessary light.
- Function switch available aside.
- Swivel base with powerful magnet.
- Swivel hanging hook.
- Application: lighting / polishing / waxing.
- Charging battery - use USB charger and USB cord connect to the USB charging port and then plug into socket for re-charging.
- Built-in 3350 mAh Li-ion battery capacity.
- LED Max power:  
nature white: 620 lumens 10W COB LED  
yellow light: 600 lumens 10W COB LED  
nature white + yellow light: 770 lumens 20W COB LED
- Charging time: 3.5 hours.
- Active time: more than 3 hours.
- Charger input: AC100-240V 50/60Hz.

**LED COB Slim work light (nature white + UV light)**



**68611U**

20/9.9/10.7/2'

378g

- Lumen switch: turn for on/off, and then turn right or left for necessary light.
- Function switch available aside.
- Swivel base with powerful magnet.
- Swivel hanging hook.
- Application : lighting / A/C refrigerant / coolant leak.
- Charging Battery – use USB charger and USB cord connect to the USB charging port and then plug into socket for re-charging.
- Built-in 3350 mAh Li-ion battery capacity.
- LED Max power:  
nature white: 620 lumens 10W COB LED  
UV light: 4.822
- Charging time: 3.5 hours.
- Active time: more than 3 hours.
- Charger input: AC100-240V 50/60Hz.

## 2-IN-1 LED Focus adjustable flashlight / COB work light



**68611S**



50/11.4/12.4/1.3'



145g

- Lumen switch: turn for on/off, and then turn right or left for necessary light.
- Focus adjustable.
- Swivel base with powerful magnet.
- Charging battery-use USB charger and USB cord connected to the USB charging port and then plug into socket for re-charging.
- Built-in 2200 mAh Li-ion battery capacity.
- LED Max power: 400 Lumens 8W COB LED + 3W tip light.
- Charger time: 3.5-4.0 hours.
- Active time: more than 3 hours.
- Charger input: AC100-240V 50/60Hz.
- Product size: 230(L) x 30(W) x 40(H) mm.

## Flash light with zoom in/out function



**68607A**



30/3.7/4.7/0.4'



122g

- Bulb type: CREE XPE LED
- Battery: AAA x 3pc or 18650 x 1pc (not included)
- Size: Ø34 x Ø27 x 116 mmL
- Three light modes: High/Low/Strobe
- Lumen: High - 240 lumen,  
Low - 100 lumen

## 20W LED Flash light



**68613**



30/6/7/0.66'



200g

- Size: 162 x 43 x 32 mm
- Lumen: 2200/1600/1100 lm
- Features 5 adaptable settings:  
High, Medium, Low, Strobe, SOS
- Working time:  
1 Hour (High) / 2 Hours (Medium) / 3 Hours (Low)  
based on 2600mAh Li battery.
- Charging time: Input 1A maximum 3 hours
- Battery: (not included)  
AAA x 3pcs or 18650 x 1pc or 26650 x 1pc
- Power: 20W
- Bulb type: P70 LED



GENERAL



**3pc Adjustable gauged wrench set - left threaded**



**5036CL**

10/14.9/15.9/0.8' 1455g

	1pc	649200L	8" (200 mmL)
	1pc	649250L	10" (250 mmL)
	1pc	649300L	12" (300 mmL)

**Super heavy duty hacksaw**



**66301A**

12/11/12/1.5' 982g

- Blade: length 12"(300mm); 24 teeth per inch; Bi-Metal HSS.
- Multi-angle adjustable blade: 45°, 90°, 135° and 180°.
- TPR grip handle design.
- Quick-change blade design.
- Storage frame for spare blades.
- Blade available (code: 66301A-B)

**8pc 45° Offset ring wrench set**



**5085P**

10/16.1/17.1/0.9' 1610g

	8pc	8x9; 10x11; 12x13; 14x15; 16x17; 18x19; 21x23; 22x24 mm
--	-----	---



## Rim wrench



**6774119**

Part no.	size	O.D. mm	<i>l</i> mm	 g	 pc/box
6774119	41 x 19sq.	25	400	1900	2

## Slugging ring wrench



**79337**

Part no.	size	mm	g	pc/box
79337	37	205	455	5



**7933.1.8**

Part no.	size	mm	g	pc/ctn
7933.1.8	3-1/8"	365	5050	4

## Plastic hanger for ring wrenches



**PI755**

Part no.	Ring sizes mm	<i>l</i> mm	 g
PI755	6-18	130	4
PI755S	19-24	105	8
PI755M	25-30	110	8
PI755L	31-52	120	12



PI755 PI755S PI755M PI755L



GENERAL



**9pc 1/4" Five-sided, Star tamper double-sized bit & bit driver set**



**20918T**

20/8.6/9.6/0.59' 430g

	4pc	1/4" T-10H x T-15H; T-20H x T-25H; T-27H x T-30H; T-35H x T-40H (165mmL)
	4pc	1/4" TS8 x TS10; TS15 x TS20; TS25 x TS27; TS30 x TS40 (165mmL)
	1pc	1/4" inhex 5" (125mm) (8152)

**1/4" Double-sized star tamperproof bit**

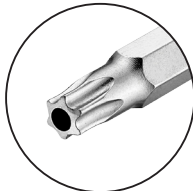

**127D**

Part no.	size	mm	g	pc/bag
127D1015	T-10H x T-15H	165	38	10
127D2025	T-20H x T-25H	165	40	10
127D2730	T-27H x T-30H	165	42	10
127D3540	T-35H x T-40H	165	42	10

**1/4" Double-sized five-sided star tamperproof bit**





**12FD**

Part no.	size	mm	g	pc/bag
127FD0810	TS8 x TS10	165	38	10
127FD1520	TS15 x TS20	165	40	10
127FD2527	TS25 x TS27	165	40	10
127FD3040	TS30 x TS40	165	42	10



**10mm Star bit** 



		<i>l</i>		
Part no.	size	mm	g	pc/bag
1767547	T47	75	45	10





**10mm Ribe bit** 



		<i>l</i>		
Part no.	size	mm	g	pc/bag
17975095	M9.5	75	46	10

**Long hex ball point key** 



	 	<i>l</i>	<i>l</i>		
Part no.	Tip	short	long	g	pc/box
76517L	17	80	267	605	5



**GENERAL**



**Single ended ring spanner, deep offset**

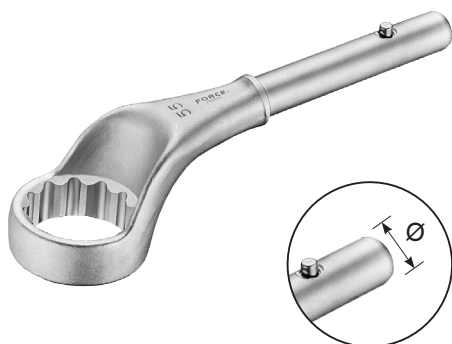

<b>795A</b>		<i>l</i>		∅	Extension bar
Part no.	size	mm	g	mm	item no.
795A24	24	180	460	19	795A460
795A27	27	190	510	19	795A460
795A30	30	200	580	19	795A460
795A32	32	235	830	22	795A610
795A36	36	245	900	22	795A610
795A38	38	265	1060	22	795A610
795A40	40	265	1050	22	795A610
795A41	41	265	1050	22	795A610
795A42	42	265	1050	22	795A610
795A46	46	280	1410	25	795A760
795A50	50	290	1630	25	795A760
795A55	55	300	1790	25	795A760
795A60	60	345	2800	30	795A860
795A65	65	355	3100	30	795A860
795A70	70	365	3300	30	795A860
795A75	75	375	3500	30	795A860
795A80	80	385	4500	30	795A860
795A85	85	385	4500	30	795A860
795A90	90	410	5450	30	795A860
795A95	95	410	5200	30	795A860
795A100	100	412	5200	30	795A860
795A105	105	412	5200	30	795A860

**Assembly:**

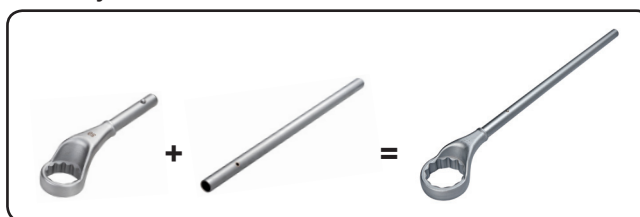

**Extension bar for single ended ring spanner**

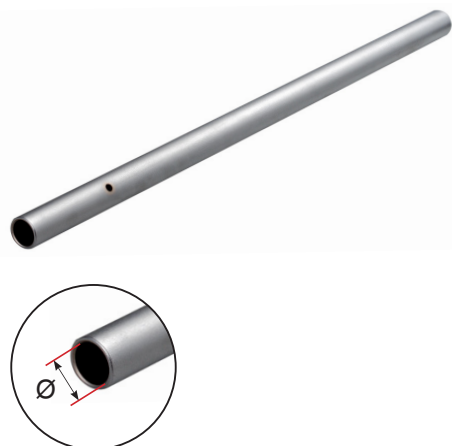

<b>795A</b>	∅	<i>l</i>	
Part no.	mm	mm	g
795A460	19	460	740
795A610	22	610	1120
795A760	25	760	1580
795A860	30	860	2510





## 5pc Adaptor set



**40513**

30/11.54/12.54/0.82' 380g

809 23...46	5pc	1/4"(F) x 3/8"(M); 3/8"(F) x 1/4"(M); 3/8"(F) x 1/2"(M); 1/2"(F) x 3/8"(M); 1/2"(F) x 3/4"(M)
-------------	-----	---

## 7pc 1/2"DR. Hex ball point socket bit set



**4076**

20/15.9/16.9/1.4' 795g

	7pc	5, 6, 7, 8, 9, 10, 12 mm (100mmL)
--	-----	-----------------------------------

## 1/4" Magnetic nut setter

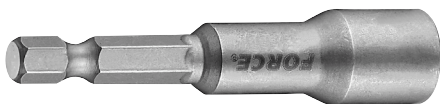

**812M**



Part no.	size	mm	g	pc/box
812M12	12	65	50	10

## 1/4"DR. Quick-release pear ratchet handle 20teeth



**802277**



Part no.	mm	g	pc/box
802277	265	466	1



GENERAL



**3/8"DR. Hex socket bit**

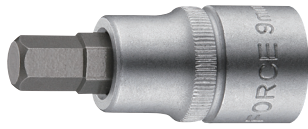

**33405011**



*l*



Part no.	size	mm	g	pc/box
33405011	11	50	62	20

11

50

62

20

**3/8"DR. 12pt. Flank socket**



**53915.16**



*l*



Part no.	size	mm	g	pc/box
53915.16	15/16"	32	72	20

15/16"

32

72

20

**3/8"DR. Quick-release flexible pear ratchet handle 45teeth**



**802313**

*l*



Part no.	mm	g	pc/box
802313	265	466	1

265

466

1

**1/2"DR. Hex socket bit**



**34405511**



*l*



Part no.	size	mm	g	pc/box
34405511	11	55	85	10

11

55

85

10

### 1/2"DR. Hex ball point socket bit

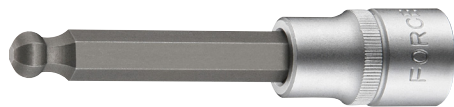

<b>345100</b>				
Part no.	size	mm	g	pc/box
34510007	7	100	83	10
34510009	9	100	105	10
34510012	12	100	145	10

### 1/2"DR. 12pt. Flank socket



<b>549</b>				
Part no.	size	mm	g	pc/box
54933	33	47	241	10
54934	34	47	247	10
54935	35	48	271	10
54936	36	48	250	10

### 1/2"DR. Spline socket



<b>54Q34</b>				
Part no.	size	mm	g	pc/box
54Q34	34	45	187	10

### 3/4"DR. 6pt. Flank socket



<b>56557</b>				
Part no.	size	mm	g	pc/box
56557	57	76	920	2



GENERAL



**3/4"DR. 12pt. Flank socket**



<b>56957</b>		<i>l</i>		
Part no.	size	mm	g	pc/box
56957	57	76	920	2

**3/4"DR. Quick-release adjustable pear ratchet handle 24teeth**



<b>8026800</b>	<i>l</i>	<i>l</i>		
Part no.	Normal(mm)	Extended(mm)	g	pc/ctn
8026800	510	800	3480	5

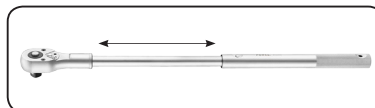

**3/4"DR. Square hole ratchet handle 36teeth**



<b>802612</b>	<i>l</i>		
Part no.	mm	g	pc/ctn
802612	505	1832	5





- 3/4" Square driver (802612D) is not included.
- It's an optional item.

### 3/4"DR. Adjustable wobble extension



**8046070W**

 60/20.1/21.1/0.5'  335g

- While partially inserted, it provides wobble feature, allowing sockets to turn 10° circularly.
- While fully inserted, it is a 70mmL extension.
- Max. Torque: 850 Nm
- Size: 3/4" (F) x 3/4" (M)



### 3/4"DR. Plastic hanger



**PI8036**

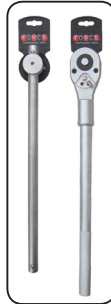

Part no.	Size	<i>l</i>	
	DR.	mm	g
PI8036	3/4"	137	28



### 1"DR. 6pt. Flank socket



**58546**

Part no.		<i>l</i>		
	size	mm	g	pc/box
58546	46	75	838	2



**1"DR. Impact wrench with 6" anvil**

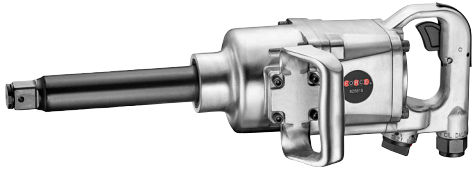

**825815**

**l**



Part no.	mm-inch	kg	pc/box
825815	515-20"	12.06	1

**Specifications:**

Square Drive .....	1"
Free Speed (R.P.M).....	4000
Max. Torque (Ft/Lbs) / (Nm).....	1860/2522
Air Pressure (PSI).....	90
Air Inlet (P.T.).....	1/2"

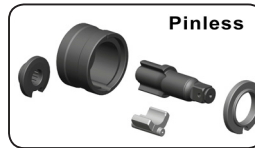

**Plastic socket rail**



**819...A**

**Size**

**l**



Part no.	DR.	psc	mm	g
819213A	1/4"	13	255	50
819317A	3/8"	17	432	92
819416A	1/2"	16	432	122

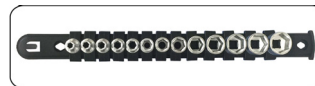

**Aluminum Magnetic QR fastener socket rail**

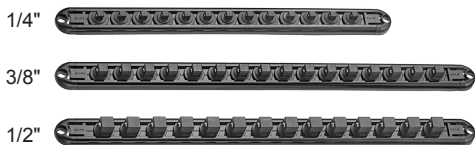

**819...M**

**Size**

**l**



Part no.	DR.	psc	mm	g
819213M	1/4"	13	300	124
819316M	3/8"	16	380	166
819414M	1/2"	14	380	186

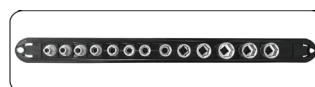

## 30pc Exchangeable impact socket bit set



**6301**

6/17.85/18.85/1.4' 2975g

19447 06...12M	4pc	17mm Hex 6, 8, 10, 12 mm (47mmL)
19457 14...22M	4pc	19mm Hex 14, 17, 19, 22 mm (57mmL)
19647 40...55M	4pc	17mm Star T40, T45, T50, T55 (47mmL)
19657 70...100M	4pc	19mm Star T70, T80, T90, T100 (57mmL)
19847 12...18M	4pc	17mm Spline M12, M14, M16, M18 (47mmL)
810417MPP	2pc	Bit holder
810619MPP		1/2"DR.x17mm(F); 3/4"DR.x19mm(F)
	4pc	Locking pin Ø5.0 x 19.5L (P2050)
	2pc	O-ring Ø24-Ø3.5 (R2435)
	2pc	O-ring Ø33-Ø5.5 (R3355)

• Locking pins and O-rings are used to fasten bits to bit holders.

## 10pc 1/2"DR. 6pt. Flank impact socket set



**4109-10**

20/25.0/26.0/0.6' 1250g

	10pc	10, 12, 13, 14, 16, 17, 19, 21, 22, 24 mm
--	------	---

## 10pc 1/2"DR. Deep impact socket set



**4107-9**

10/26.9/27.9/0.7' 2690g

	10pc	10, 12, 13, 14, 16, 17, 19, 21, 22, 24 mm (85mmL)
--	------	---

**4107-10**

10/26.7/27.7/0.7' 2690g

	10pc	11, 12, 13, 14, 16, 17, 19, 21, 22, 24 mm (85mmL)
--	------	---



GENERAL



**7pc 1"DR. 6pt. Flank impact socket set (SAE)**



**8071S**

2/25/26/1.1'

2500g

		7pc	1-7/8"; 2"; 2-3/16"; 2-1/4"; 2-1/2"; 2-5/8"; 2-3/4"
--	--	-----	---

**1/2"DR. 12pt. Flank impact socket**



**44834**

Part no.	size	mm	g	pc/box
44834	34	50	256	10

**3/4"DR. 6pt. Flank deep impact socket**



**465**

Part no.	size	mm	g	pc/box
46510062	62	100	1900	1
46510064	64	100	2000	1
46512070	70	120	2656	1

**3/4"DR. 12pt. Flank deep impact socket**

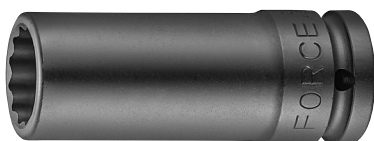



**46810024**

Part no.	size	mm	g	pc/box
46810024	24	100	454	1





### 3/4"DR. Spline impact socket bit (one-piece)



<b>2689018</b>		<i>l</i>		
Part no.	size	mm	g	pc/box
2689018	M18	90	430	2



### 1"DR. 6pt. Flank impact socket



<b>48551</b>		<i>l</i>		
Part no.	size	mm	g	pc/box
48551	51	75	1090	1



### 1"DR. 6pt. Flank middle deep impact socket



<b>4858046</b>		<i>l</i>		
Part no.	size	mm	g	pc/box
4858046	46	80	1091	1

### 1"DR. 6pt. Flank deep impact socket



<b>48510040</b>		<i>l</i>		
Part no.	size	mm	g	pc/box
48510040	40	100	1120	1



GENERAL



Beer opener



**G51**

	<i>l</i>		
Part no.	mm	g	pc/bag
G51	121	44	1

Tool holders rail (w/ two back clips)



**82031**

		<i>l</i>	
Part no.	psc	mm	g
820311	11	438	178
820312	12	438	298

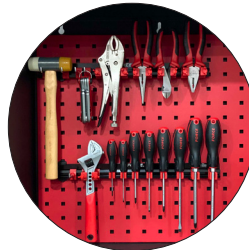

## OnSupply tool display package 265pcs

**OS52265**

 1/128/143/14.2'

 128KG

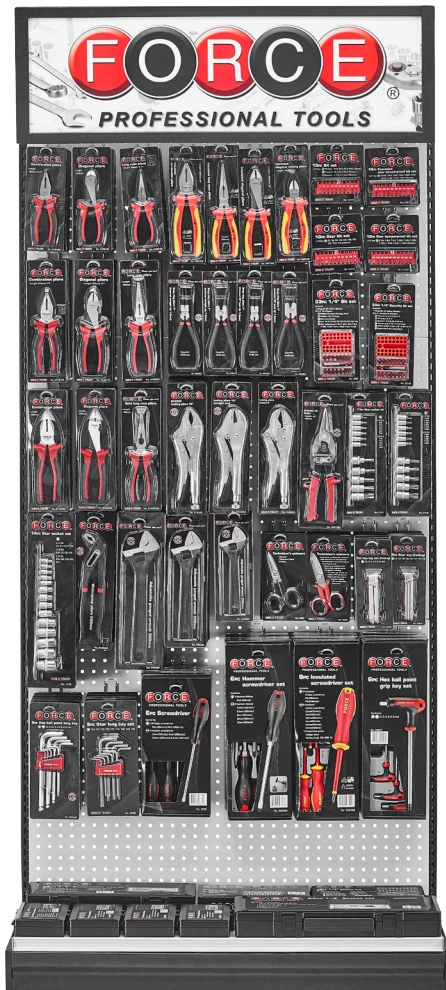

1pc Tool display stand (w/o extra plate board or hooks)  
44pc 8" U shaped hook with screws (for round hole)

5set 21010	10pc 1/4" Bit set
5set 21012	10pc 1/4" Star bit set
5set 21012T	10pc 1/4" Star tamperproof bit set
5set 21013	10pc 1/4" Five-sided star tamperproof bit set
5set 2331A	33pc 1/4" Security bit set
5set 2332	33pc 1/4" Bit set
1set 4155	15pc 10mm Hex bit set
1set 4156	15pc 10mm Star bit set
1set 4112	11pc 10mm Spline bit set
3set 2068	6pc Screwdriver set
3set 20610A	6pc Hammer screwdriver set
3set 20916N	9pc Insulated screwdriver set
5set 5072F	7pc Hex key set (folding)
5set 5093LB	9pc Long hex ball point key set
5set 5083F	8pc Star key set (folding)
5set 5098L	9pc Long star key set
3set 50637	6pc Hex & hex ball point grip key set
5set 2111I	11pc 1/4" & 3/8" Star socket bit set
5set 2112I	11pc 1/4" & 3/8" Star tamperproof socket bit set
1set 2421-8	42pc 1/4"DR. 6pt. Flank socket combination set
1set 2462	46pc 1/4"DR. 6pt. Flank socket combination set
1set 3361-8	36pc 3/8"DR. 6pt. Flank socket & combination wrench set
5set 4158	14pc 1/4" & 3/8" & 1/2" Star socket set
1set 4171	16pc 1/2"DR. Star set
1set 4243-5	24pc 1/2"DR. 6pt. Flank socket combination set
5pc 609ABC	Snap ring pliers internal 90° bent tip 7"(180mm)
5pc 609ABO	Snap ring pliers external 90° bent tip 7"(180mm)
5pc 609ASC	Snap ring pliers internal straight tip 7"(180mm)
5pc 609ASO	Snap ring pliers external straight tip 7"(180mm)
5pc 610B160	Long nose pliers 6.3"(160mm)
5pc 610B200	Long nose pliers 8"(200mm)
5pc 610B200B	Bent long nose pliers 8"(200mm)
5pc 611B160	Combination pliers 6.3"(160mm)
5pc 611B175	Combination pliers 7"(175mm)
5pc 611B200	Combination pliers 8"(200mm)
5pc 612B160	Diagonal pliers 6.3"(160mm)
5pc 612B175	Diagonal pliers 7"(175mm)
5pc 612B200	Diagonal pliers 8"(200mm)
5pc 613B250	Waterpump pliers 10"(250mm)
5pc 614250	Locking pliers 10"(250mm)
5pc 614A250	Locking pliers (straight jaw) 10"(250mm)
5pc 614B225	Locking pliers (V-jaw) 9"(225mm)
5pc 649200	Adjustable gauged wrench 8"(200mm)
5pc 649250	Adjustable gauged wrench 10"(250mm)
5pc 649300	Adjustable gauged wrench 12"(300mm)
5pc 6903200	Insulated combination pliers 8"(200mm)
5pc 6904200	Insulated long nose pliers 8"(200mm)
5pc 6905160	Insulated diagonal cutting pliers 6.3"(160mm)
5pc 6911200	Insulated diagonal pliers 8"(200mm)
5pc 6981250	Aviation tin snips straight cut 10"(250mm)
5pc 6982	Technician's scissors 145mmL
5pc 6983	Technician's scissors 145mmL



GENERAL

Part No.	Page	Part No.	Page	Part No.	Page	Part No.	Page
127D	8-83	53580...M	2-36	65109	7-71	8046070W	8-90
12FD	8-83	53915.16	8-87	65607A	8-78	8071S	8-93
1767547	8-84	549	8-88	66301A	8-81	8083...M	2-37
17975095	8-84	54Q34	8-88	6774119	8-82	812M	8-86
20918T	8-83	56557	8-88	678A01	8-77	8173	8-76
20919	8-73	56957	8-89	68021	8-77	8176	4-59
2689018	8-94	58546	8-90	6806A	2-34	8176	8-76
3041	1-1	608A	6-65	681F400	3-45	818B	8-74
3263	8-75	61918	1-20	684D	8-78	819...A	8-91
334...M	2-36	61936	1-22	685A20	7-71	819...M	8-91
33405011	8-87	61937	1-27	68607A	8-80	82031	8-95
34405511	8-87	61938	1-23	68611S	8-80	82431	6-66
345100	8-88	61939	4-57	68611U	8-79	825412	1-29
40513	8-86	62004	1-20	68611Y	8-79	825815	8-91
4076	8-86	62114A	1-20	68613	8-80	827M02	3-52
4107-10	8-92	62115	4-58	6915220	2-35	829	2-38
4107-9	8-92	62116	1-19	6930240	8-78	88411	2-38
4109-10	8-92	62532	1-12	6982M	2-38	88423A	2-33
443	1-27	62822	3-52	764...N	2-37	88432A	2-33
443150	1-28	6301	8-92	76517L	8-84	88436	2-33
44834	8-93	6318514	1-21	766...N	2-37	88437	2-39
465	8-93	6318716	1-21	77409B	6-65	88438	2-32
46611022	4-57	6318915A	1-21	7933.1.8	8-82	88439	2-31
46611030	4-57	647...J	7-68	79337	8-82	88445	2-34
46611032	4-57	647...K	7-67	793A6	4-60	885G01	1-19
46810024	8-93	647B1000D	7-70	793A9	4-60	885G02	1-23
48510040	8-94	647G	7-69	795A	8-85	885G11	2-31
48551	8-94	647G...A	7-69	795A	8-85	885G12	2-32
4858046	8-94	647G4075	7-70	802277	8-86	902G27	1-11
5036CL	8-81	647G6250	7-70	802313	8-87	902G28	1-1
5055P403	8-78	647H	7-71	802320M	2-37	902G29	1-13
5085P	8-81	65108	3-45	802612	8-89	902T5	3-43
5096P9...A	8-73	65108	7-71	8026800	8-89	902T6	3-42
535...M	2-36	65109	3-45	804...F	8-73	902T7	3-53

Part No.	Page	Part No.	Page	Part No.	Page	Part No.	Page
903G25	1-25	909T8	3-48	9G0123A	1-18	9M1502	5-61
903G26	1-19	909T9	3-54	9G0129A	1-7	9T0108	3-41
903G28	1-14	910G10	1-8	9G0131	1-27	9T0109	3-41
903M2	5-61	910T2	3-49	9G0132	1-24	9T0207	3-55
903T10	3-43	911G10	1-3	9G0133	1-24	9T0207L	3-55
903T7	3-45	911G11	1-4	9G0209	1-25	9T0208	3-46
903T8	3-50	911T2	3-46	9G0618	1-7	9T0209	3-53
903T9	3-41	911T3	4-60	9G0619	1-9	9T0211	3-44
904G22	1-22	912G13	1-5	9G0620	1-9	9T0318	3-42
904G23	1-15	912G15	1-3	9G0621	1-10	9T0319	3-52
904G24	1-26	912G17	1-14	9G0710B	1-13	9T0408D	3-47
904T10	3-50	912M1	5-62	9G0729	1-12	9T07	3-42
904T9	4-58	912T7	3-47	9G0730	1-13	9T3613	3-53
905G23	1-2	912T8	3-56	9G0731	1-14	9TS4KM	4-59
905G25	1-9	912U8	8-75	9G0732	1-26	9TS6KM	4-59
905G26	1-8	913G9	1-16	9G0733	4-58	9U0207	8-74
905G27	1-17	913T3	3-54	9G0735	4-58	9US4	8-74
905G28	1-2	915G7	1-12	9G0736	1-26	9Y0189	6-65
905M8	5-62	915T1	7-72	9G0810	1-5	G51	8-95
906G11	1-28	916G7	1-4	9G0811	1-6	K50641N	2-35
906G12	1-23	916G8	1-6	9G0812	1-6	K50926N	2-35
906T8	3-49	921G3	1-17	9G0813	1-11	OS52265	8-96
907G20	1-2	921T2	3-48	9G0814	1-11	PI755	8-82
907G21	1-1	922G7	1-5	9G1221	1-10	PI8036	8-90
907G22	1-28	922G8	1-18	9G1502	1-18		
907M2	5-61	923G1	1-15	9G4006	1-17		
907T7	3-49	925U2	8-76	9G4109	1-29		
907T8	3-47	927T2	3-51	9G4126	1-29		
907T9	3-43	938G2	1-16	9M0109	5-64		
908G10	1-24	952T1	3-51	9M0110	5-63		
908G19	1-25	9B0402A	3-44	9M0111	5-63		
909T10	3-48	9B0402B	3-44	9M0112	5-62		
909T3	4-59	9B3502	3-44	9M0208	5-63		
909T7	3-46	9C2010	2-31	9M0209	5-64		



**Shyang Yun Tools Co., Ltd.**  
**Shyang Yun Hardware Co., Ltd.**

No.161, Sitou Rd., Shengang Dist., Taichung City 42953, Taiwan

Tel: +886-4-25631268 Fax: +886-4-25632678

<http://www.force.com.tw> E-mail: [info@force.com.tw](mailto:info@force.com.tw)

